

POWER FACTOR CORRECTION LOW VOLTAGE



Power Factor Correction
equipment and
Harmonic Filters.



Save Your **Energy.**

Introduction

COMAR Condensatori S.p.A.	1
Capacitor Characteristics	3
Power Factor	5
Power Factor Correction	6
Why is P.F.C. important?	7
P.F.C. Strategies	8
Sizing of P.F.C. equipment	9
Harmonics and Filtering	10
Choice of P.F.C. equipment	11
Fixed PFC of Transformers	12
Fixed PFC of Three-phase Asynchronous Motors	13

Fixed Power Factor Correction

GS - CS	15
RFIX	17

Automatic Power Factor Correction

GE 230V	21
B15	23
B35	25
B50	27
DMP-FTV	29

Automatic P.F.C. with Detuning Reactors

AAR/100	33
AAR/138	35
AAR/600	37
AAR/D20	39

Automatic P.F.C. with Static Insertion

B35-ST	43
AAR/100-ST	45

Passive Filters and Passive Modular Three-Phase Filters

FA05	49
FAM05	51
FAM05/07	53

Active Modular Filters

SAF-M	56
-------	----

Mechanical Drawings

A photograph of a modern building facade with large windows and a prominent sign for 'COMAIR Condensatori'. The sign is mounted on a light-colored wall and features the word 'COMAIR' in large, bold, blue letters, with 'Condensatori' written below it in a smaller, blue, cursive font. The building has a series of large windows reflecting the sky and trees. The overall scene is brightly lit, suggesting a sunny day.

COMAIR
Condensatori

Introduction

Since 1968 we provide standard products, as well as tailor-made solutions, depending on the needs of the Customer. We are leaders in the production of single-phase and three-phase **capacitors**, **power factor correction** equipment including those with blocking / de-tuning inductances, and **filters** for harmonic reduction.

Installers, design companies and end users find answers to their needs regarding both the correction of the power factor and the reduction of harmonics in electrical networks.

Strengthened by the value that **Made in Italy** represents, we sell in over 90 countries worldwide, thanks to a sales network that guarantees the availability of COMAR solutions for power factor correction on every continent.

Vision

We firmly believe that the increased electricity demand of the developed and emerging countries must be faced first of all with the reduction of waste.

Power Factor Correction plays a fundamental role in the "intelligent" exploitation of the energy currently produced, in fact it postpones and limits the creation of new power plants, and it contributes to the **environment protection**, by reducing atmospheric emissions and non-renewable fuel consumption..

Mission



Provide state-of-the-art engineering solutions that, in addition to compliance with quality and safety standards, are also appreciated by Customers for their flexibility, respect of delivery times, ease of installation and maintenance,



Quality & Certifications

The excellence of COMAR Condensatori products is possible thanks to Italian supply chain, fully under control in our factory located near Bologna. The path to ensure the quality of the methods of design, procurement, production, testing and delivery sees the achievement of the **ISO 9001**, **ISO 14001** and **OHSAS 18001** certifications.

The quality of the company system permeates the products, which comply with the requirements of the main international regulations in the sector. All COMAR solutions, contained in this catalog, comply with the European directives for low voltage, concerning the minimum safety requirements and the emission / immunity of electrical devices:

- IEC/EN 60831-1/2 for capacitors, verified by the laboratories  **IMQ**
- IEC/EN 61439-1/2 and IEC/EN 61921 for P.F.C. equipment, verified by  **DEKRA**  **CESI**

All the products made by COMAR Condensatori are labelled with **CE marking**.

Materials & Environment

Thanks to constant work with suppliers, we guarantee the compliance of our products with the **RoHS** and **REACH** directives. Particular attention is given to the substances published in the SVHC list. We recommend that the out-of-service capacitors are disposed according to the local laws and regulations in force in each country. For EU countries the European Directives 91/156 / EEC, 91/689 / EEC apply and the capacitors disposal shall be in compliance with the European Waste Identification Code (CER 2002).

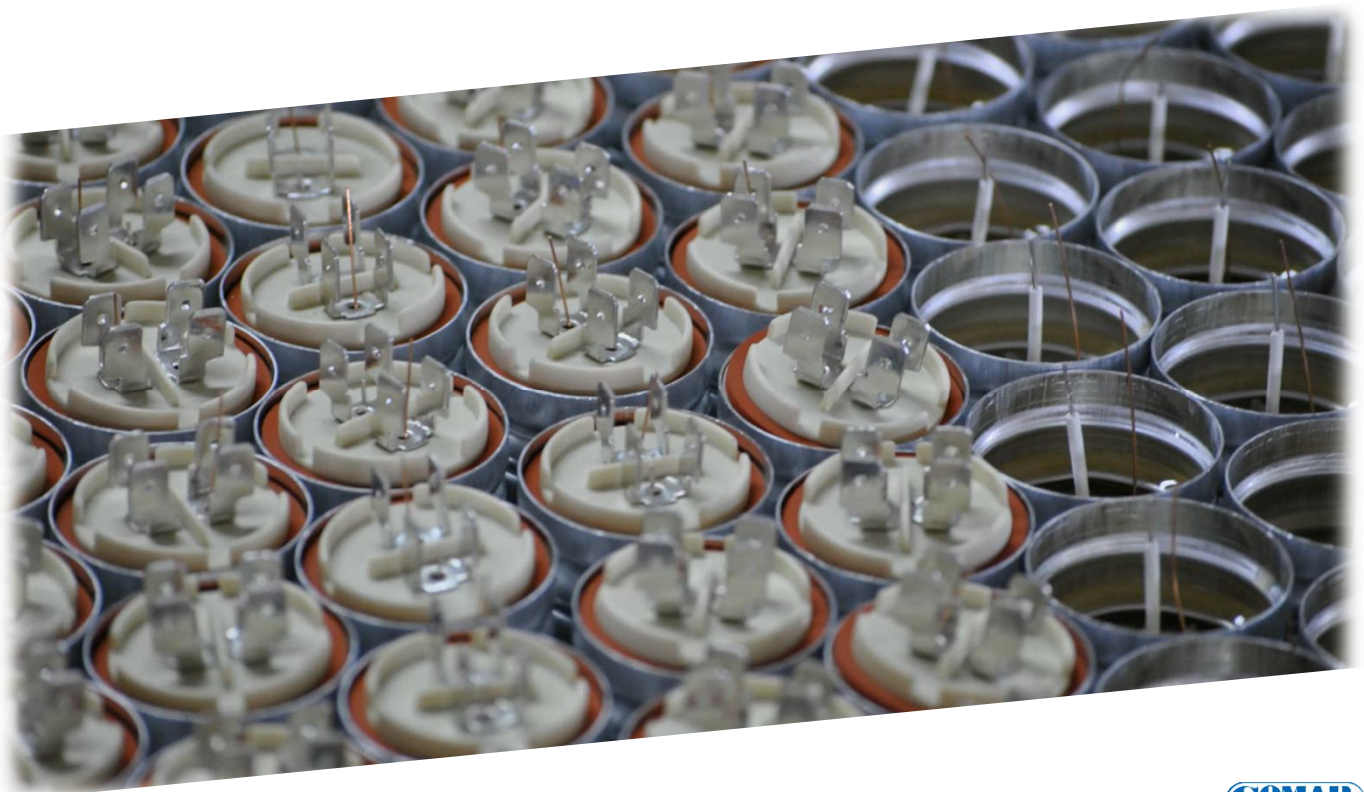

Capacitor Characteristics

Our strength lies both in the design of the P.F.C solution and in the constructive experience of the main element: the capacitor. In fact, our **metallized polypropylene (MKP)** capacitors are made of a bi-oriented polypropylene dielectric with low shrinkage and high mechanical properties. The most relevant feature of this type of film is the **self-healing of the dielectric** that allows the restoration of the electrical functionality:



Dielectric Micro short-circuit

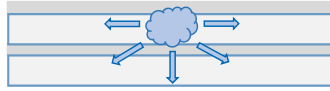

Film and surface metallization melting



Isolation of the damaged area

The maximum allowable voltage on the capacitors is reported (CEI EN 60831-1) below:

Type	Overvoltage factor	Maximum duration	Remarks
Industrial frequency*	1	continuous	Maximum average value during period of energization
Industrial frequency*	1,1	8h every 24h	Adjustment and fluctuations of the mains voltage
Industrial frequency*	1,15	30 min every 24h	Adjustment and fluctuations of the mains voltage
Industrial frequency*	1,2	5 min	Voltage increase at low load
Industrial frequency*	1,3	1 min	Voltage increase at low load
Industrial frequency	Value such that the current does not exceed the maximum value of 1.5 In (overcurrent factor consequence of the combined effects of harmonics, overvoltages and capacity tolerance)		

* without harmonics

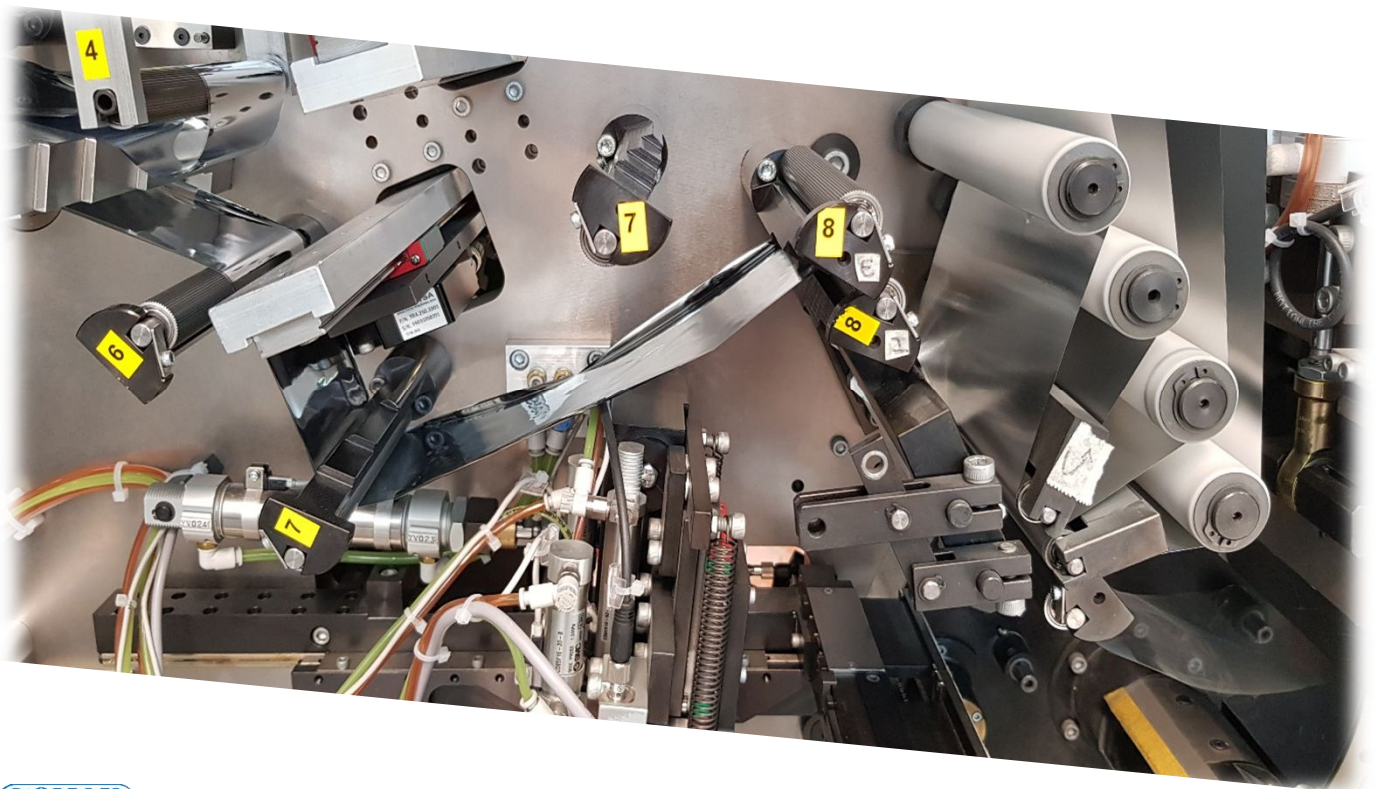

The technological and methodological measures adopted during the construction guarantee that our capacitor keeps its electrical characteristics stable over time. Below are summarized the key characteristics when temperature changes:

Delta C/C %

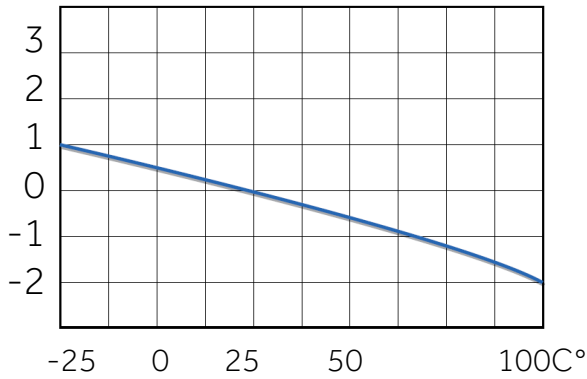

Tang. Delta

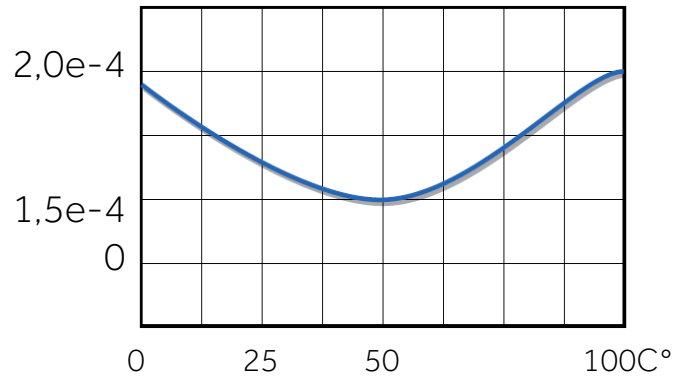

All capacitors are equipped with an **overpressure safety device** which, in the event of an internal short-circuit, disconnects the capacitor isolating it from the electrical network. This system is mechanical, based on the expansion of the metal housing and the consequent breaking of the internal connection wires.

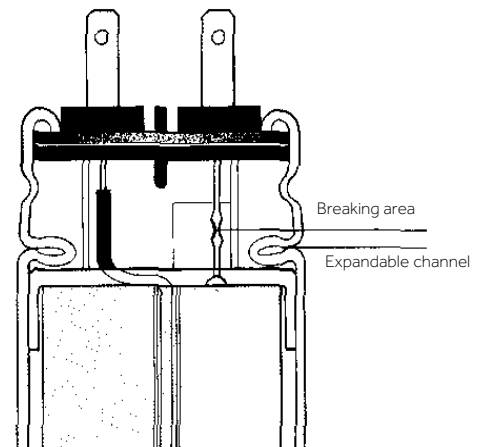

The formation of electric arcs inside is prevented by the presence of **insulating oil**, of vegetable type, which immediately penetrates the breaking point of the wires.

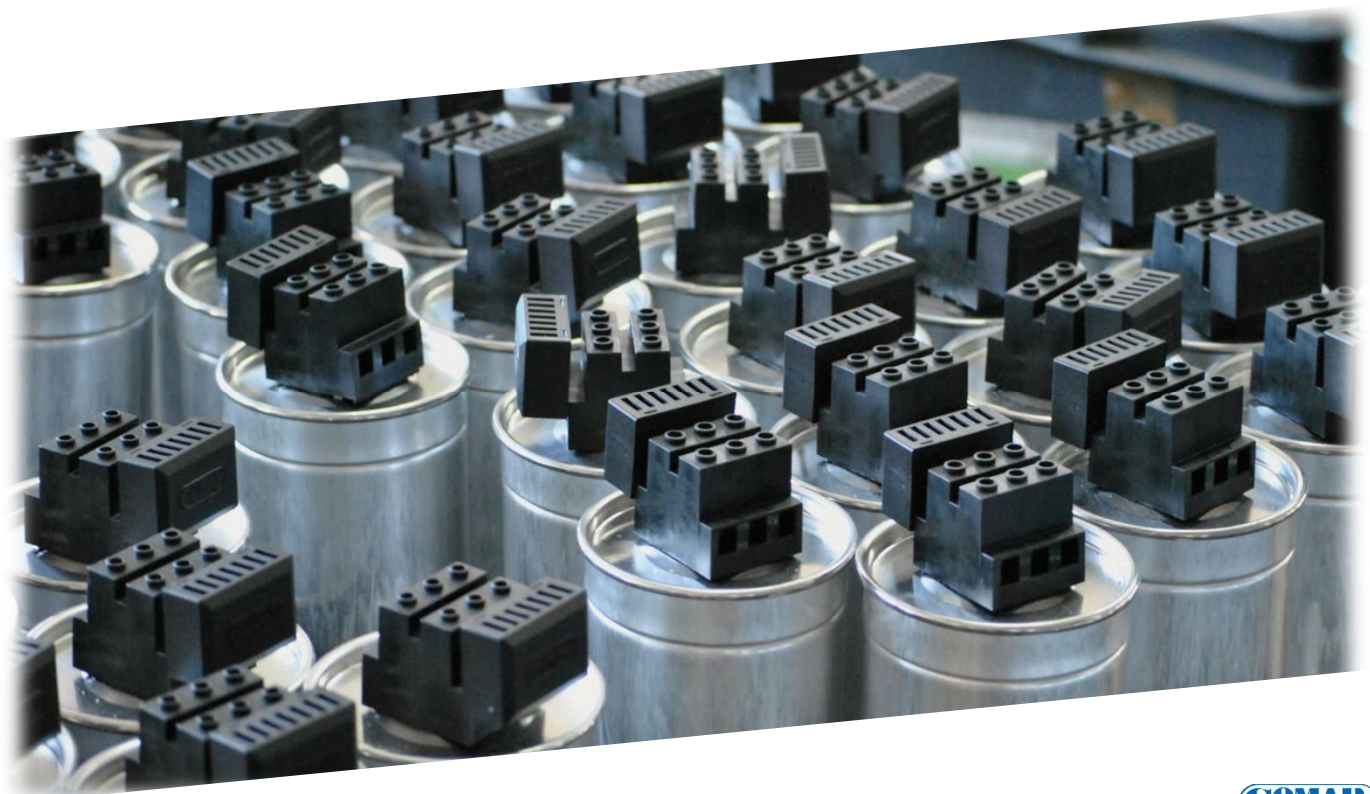

Power Factor

Consider an alternating current circuit, consisting of an electrical power source and a load: the voltage and current waveforms are of a sinusoidal type.

For its operation, the load consumes active energy (kWh), necessary to produce work and reactive energy (kvarh) that does not contribute to the performance of the work, but causes an increase in unwanted consumption.

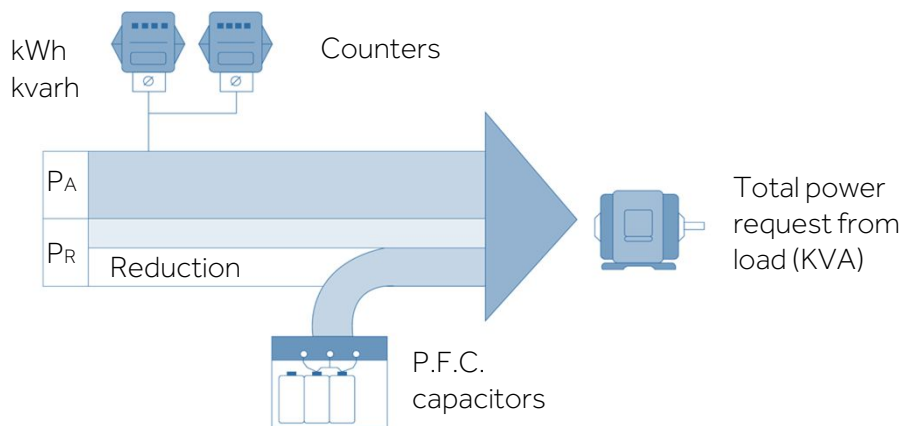

Most of the loads, in today's electrical distribution systems, are inductive, requiring two types of power:

- **Active Power (P_A)** that performs the work of the machine (eg mechanical, hydraulic, ...) and is measured in kW (kilowatt);
- **Reactive Power (P_R)** which constantly flows towards the load and then returns to the source and is measured in kvar (kilovolt-ampere reactive).

Active Power and Reactive Power constitute the **Apparent Power** that is measured in kVA (kilovolt ampere). **Power Factor (cosφ)** is simply the ratio between Active Power and Apparent Power:

$$\cos\varphi = \frac{kW}{kVA}$$

A high Reactive Power leads to an increase in the problems of managing electrical systems; the main ones include the need to oversize transformers, cables and other elements in the power supply circuit as a result of increased heating and voltage drop. This causes an increase in installation costs.

The solution to these problems is given by the **Power Factor Correction**: a measure to improve the power factor of a load, in order to reduce the value of the current flowing on the network to the same active power (kW). Re-phasing, therefore, means **decreasing the reactive power absorbed by the load** that passes through a certain section of the network, until it is canceled at **$\cos\phi = 1.00$** .

Energy distributor impose a minimum limit to $\cos\phi$ in order to reduce the circulation of reactive energy along the power lines.

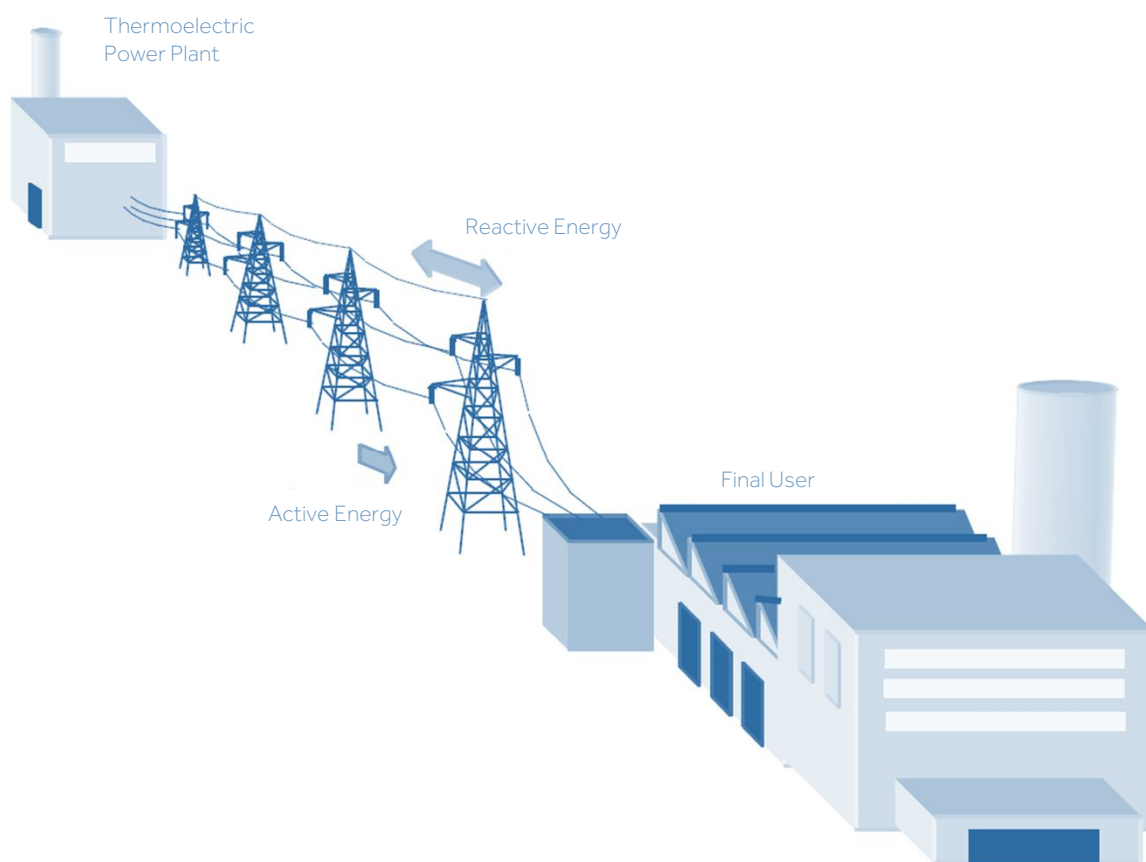

The maximum possible power factor is 1.00, which means that 100% of the power delivered to the load is the active power converted into useful energy. Any value less than 1.00 indicates that the load supply system must be oversized.

Traditionally, concern for the power factor has been almost exclusively linked to the use of induction motors. Today, however, this is extended to other non-linear loads, such as power electronic devices (e.g. variable speed drives, uninterruptible power supplies), induction furnaces, arc welding machines, ...

Why is P.F.C. important?

Electric capacitors are one of the most cheap and simple sources of energy saving currently known, which allow both the distributor and the company to save money.

Power factor correction determines a **rational use of electric power**, reducing the undesired effects of load currents such as motors, transformers, etc., and **losses due to the joule effect** in the cables and devices (switches, transformers) present on the energy transport system.

The additional costs that would be incurred, without P.F.C., are so high that they determine a return on investment of 12/18 months. Indeed, increasing the power factor of electrical systems offers the following advantages:

Reduction of the costs of electric users

The difference between active and apparent power forces the electricity supply company to supercharge the distribution system: the penalties therefore want to incentivize the customer to improve the low power factor.



Increased available power

By reducing the kvar demand on the load side and installing the capacitors, the maximum power that can be supplied by the generators and transformers is available.



Improvement of the voltage

The demand for high load kvar increases the voltage drops between the transformers, cables and other system components, with a consequent reduction and flickering of voltage at the equipment.



Reduction of losses due to cable heating

The circuit current is reduced in direct proportion to the increase of the power factor, the I^2R loss or the resistive loss in the circuit is inversely proportional to the square of the current.



Distributed power factor correction

The power factor correction equipment is installed close to the individual loads and sized for the required reactive power. Considering that the effect of the capacitors is affected upstream of the installation point, it is the ideal solution to compensate for high inductive currents.

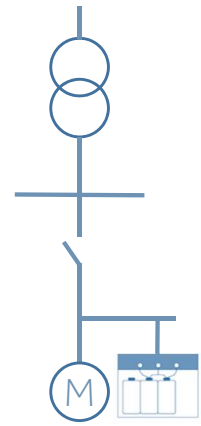

P.F.C. of groups of loads

Automatic systems, guarantee the P.F.C. of several users, following the request for reactive energy. For high power users, the choice of correcting locally large loads and centrally the remaining power, is usually the most advantageous technical-economic solution.

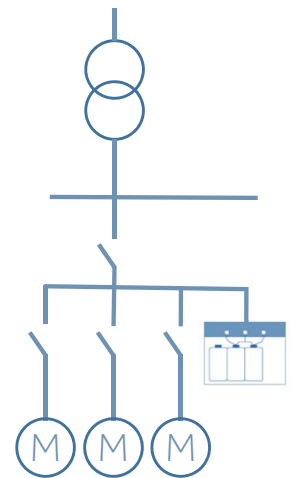

Centralized power factor correction

Installation of a single automatic panel, typically at the transformer or energy delivery point, is the most used and the easiest solution to implement.

It is ideal for small and medium-sized companies and the savings for the user are directed essentially to the elimination of the penalties on the bills.

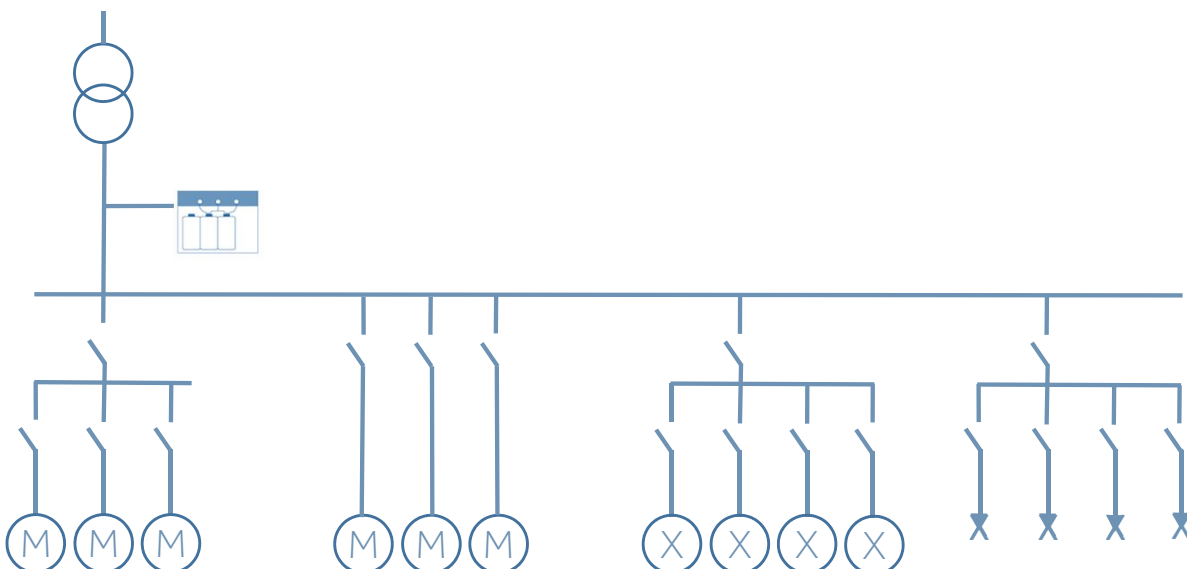

Sizing of P.F.C. equipment

The reactive power can be balanced by the presence of rephasing using the following equation:

$$kvar_{PFC} = kW_{Load} \cdot (\tan\phi_1 - \tan\phi_2) = kW_{Load} \cdot M$$

Knowing that: $\tan\phi_1 = kvarh / kWh$

M can be calculated using the following table:

		tanφ2															
		cosφ2															
tanφ1		cosφ1															
		0,62	0,59	0,57	0,54	0,51	0,48	0,46	0,43	0,4	0,36	0,33	0,29	0,25	0,2	0,14	0
		0,85	0,86	0,87	0,88	0,89	0,9	0,91	0,92	0,93	0,94	0,95	0,96	0,97	0,98	0,99	1
4,90	0,2	4,28	4,31	4,33	4,36	4,39	4,41	4,44	4,47	4,5	4,54	4,57	4,61	4,65	4,7	4,76	4,9
3,87	0,25	3,25	3,28	3,31	3,33	3,36	3,39	3,42	3,45	3,48	3,51	3,54	3,58	3,62	3,67	3,73	3,87
3,18	0,3	2,56	2,59	2,61	2,64	2,67	2,7	2,72	2,75	2,78	2,82	2,85	2,89	2,93	2,98	3,04	3,18
2,68	0,35	2,06	2,08	2,11	2,14	2,16	2,19	2,22	2,25	2,28	2,31	2,35	2,38	2,43	2,47	2,53	2,68
2,29	0,4	1,67	1,7	1,72	1,75	1,78	1,81	1,84	1,87	1,9	1,93	1,96	2	2,04	2,09	2,15	2,29
1,98	0,45	1,36	1,39	1,42	1,44	1,47	1,5	1,53	1,56	1,59	1,62	1,66	1,69	1,73	1,78	1,84	1,98
1,73	0,5	1,11	1,14	1,17	1,19	1,22	1,25	1,28	1,31	1,34	1,37	1,4	1,44	1,48	1,53	1,59	1,73
1,52	0,55	0,9	0,93	0,95	0,98	1,01	1,03	1,06	1,09	1,12	1,16	1,19	1,23	1,27	1,32	1,38	1,52
1,33	0,6	0,71	0,74	0,77	0,79	0,82	0,85	0,88	0,91	0,94	0,97	1	1,04	1,08	1,13	1,19	1,33
1,23	0,63	0,613	0,639	0,666	0,693	0,72	0,748	0,777	0,807	0,837	0,87	0,904	0,941	0,982	1,03	1,09	1,233
1,17	0,65	0,55	0,58	0,6	0,63	0,66	0,68	0,71	0,74	0,77	0,81	0,84	0,88	0,92	0,97	1,03	1,17
1,14	0,66	0,519	0,545	0,572	0,599	0,626	0,654	0,683	0,712	0,743	0,775	0,81	0,847	0,888	0,935	0,996	1,138
1,11	0,67	0,488	0,515	0,541	0,568	0,596	0,624	0,652	0,682	0,713	0,745	0,779	0,816	0,857	0,905	0,966	1,108
1,08	0,68	0,459	0,485	0,512	0,539	0,566	0,594	0,623	0,652	0,683	0,715	0,75	0,787	0,828	0,875	0,936	1,078
1,05	0,69	0,429	0,456	0,482	0,509	0,537	0,565	0,593	0,623	0,654	0,686	0,72	0,757	0,798	0,846	0,907	1,049
1,02	0,7	0,4	0,43	0,45	0,48	0,51	0,54	0,56	0,59	0,62	0,66	0,69	0,73	0,77	0,82	0,88	1,02
0,99	0,71	0,37	0,4	0,43	0,45	0,48	0,51	0,54	0,57	0,6	0,63	0,66	0,7	0,74	0,79	0,85	0,99
0,96	0,72	0,34	0,37	0,4	0,42	0,45	0,48	0,51	0,54	0,57	0,6	0,64	0,67	0,71	0,76	0,82	0,96
0,94	0,73	0,32	0,34	0,37	0,4	0,42	0,45	0,48	0,51	0,54	0,57	0,61	0,64	0,69	0,73	0,79	0,94
0,91	0,74	0,29	0,32	0,34	0,37	0,4	0,42	0,45	0,48	0,51	0,55	0,58	0,62	0,66	0,71	0,77	0,91
0,88	0,75	0,26	0,29	0,32	0,34	0,37	0,4	0,43	0,46	0,49	0,52	0,55	0,59	0,63	0,68	0,74	0,88
0,86	0,76	0,24	0,26	0,29	0,32	0,34	0,37	0,4	0,43	0,46	0,49	0,53	0,56	0,6	0,65	0,71	0,86
0,83	0,77	0,21	0,24	0,26	0,29	0,32	0,34	0,37	0,4	0,43	0,47	0,5	0,54	0,58	0,63	0,69	0,83
0,80	0,78	0,18	0,21	0,24	0,26	0,29	0,32	0,35	0,38	0,41	0,44	0,47	0,51	0,55	0,6	0,66	0,8
0,78	0,79	0,16	0,18	0,21	0,24	0,26	0,29	0,32	0,35	0,38	0,41	0,45	0,48	0,53	0,57	0,63	0,78
0,75	0,8	0,13	0,16	0,18	0,21	0,24	0,27	0,29	0,32	0,35	0,39	0,42	0,46	0,5	0,55	0,61	0,75
0,72	0,81	0,1	0,13	0,16	0,18	0,21	0,24	0,27	0,3	0,33	0,36	0,4	0,43	0,47	0,52	0,58	0,72
0,70	0,82	0,08	0,1	0,13	0,16	0,19	0,21	0,24	0,27	0,3	0,34	0,37	0,41	0,45	0,49	0,56	0,7
0,67	0,83	0,05	0,08	0,11	0,13	0,16	0,19	0,22	0,25	0,28	0,31	0,34	0,38	0,42	0,47	0,53	0,67
0,65	0,84	0,03	0,05	0,08	0,11	0,13	0,16	0,19	0,22	0,25	0,28	0,32	0,35	0,4	0,44	0,5	0,65
0,62	0,85		0,03	0,05	0,08	0,11	0,14	0,16	0,19	0,22	0,26	0,29	0,33	0,37	0,42	0,48	0,62
0,59	0,86			0,03	0,05	0,08	0,11	0,14	0,17	0,2	0,23	0,26	0,3	0,34	0,39	0,45	0,59
0,57	0,87				0,03	0,05	0,08	0,11	0,14	0,17	0,2	0,24	0,28	0,32	0,36	0,42	0,57
0,54	0,88					0,03	0,06	0,08	0,11	0,14	0,18	0,21	0,25	0,29	0,34	0,4	0,54
0,51	0,89						0,03	0,06	0,09	0,12	0,15	0,18	0,22	0,26	0,31	0,37	0,51
0,48	0,9							0,03	0,06	0,09	0,12	0,16	0,19	0,23	0,28	0,34	0,48
0,46	0,91								0,03	0,06	0,09	0,13	0,16	0,2	0,25	0,31	0,46
0,43	0,92									0,03	0,06	0,1	0,13	0,18	0,22	0,28	0,43
0,40	0,93										0,03	0,07	0,1	0,14	0,19	0,25	0,4
0,36	0,94											0,03	0,07	0,11	0,16	0,22	0,36

Example:

$\cos\phi_1 = 0,71$, original power factor (before correction)

$\cos\phi_2 = 0,97$, target power factor (after correction)

$M = 0,74$

Therefore, given a load of 1000kW, it will be necessary to use a power factor correction of 740kvar.

The presence of non-sinusoidal currents in industrial plants produces undesired phenomena and in some situations real operating anomalies, that grow when the intensity of the **harmonic components** is higher..

To quantify the presence of all the harmonics, the **THD (Total Harmonic Distorsion)** factor has been introduced:

$$\text{THD}\% = 100 \times \sqrt{\sum_{n=2}^N \left(\frac{A_n}{A_1}\right)^2}$$

A_1 = amplitude of the fundamental

A_n = amplitude of the harmonic of order n

N = higher degree of harmonic order

In order to carry out power factor correction when high harmonic currents are present, it is necessary to choose equipment with blocking reactors (detuned inductances) that are arranged in series with the capacitors, so as to compose an LC branch that has a tuning frequency at a lower value than the lowest harmonic. Typically it is equal to:

- **189 Hz (7%)** when the lowest is the **5th harmonic**
- **138 Hz (14%)** when the lowest is the **3rd harmonic**

In industrial plants, where the loads power can be very high, any harmonic component may not be acceptable: therefore, a real action of reducing, if not eliminating, the harmonics is required.

For this purpose **passive filters** are the traditional means of resolution. This equipment consists of several LC branches in each of which the resonant frequency coincides with one of the undesired harmonic frequencies.

The system thus composed constitutes a preferential path through which the harmonic currents find a way to close again and do not affect the upstream network.

Appropriate design is needed to avoid resonance phenomena.

Further information on harmonics can be found in the "Technical Information" on our website www.comarcond.com.

Choice of P.F.C. equipment

We offer a wide range of power factor correction systems, depending on the harmonic content in the network. We always recommend, to carry out the necessary measurements on the electricity grid, in order to estimate the harmonic distortion rate (THDI).

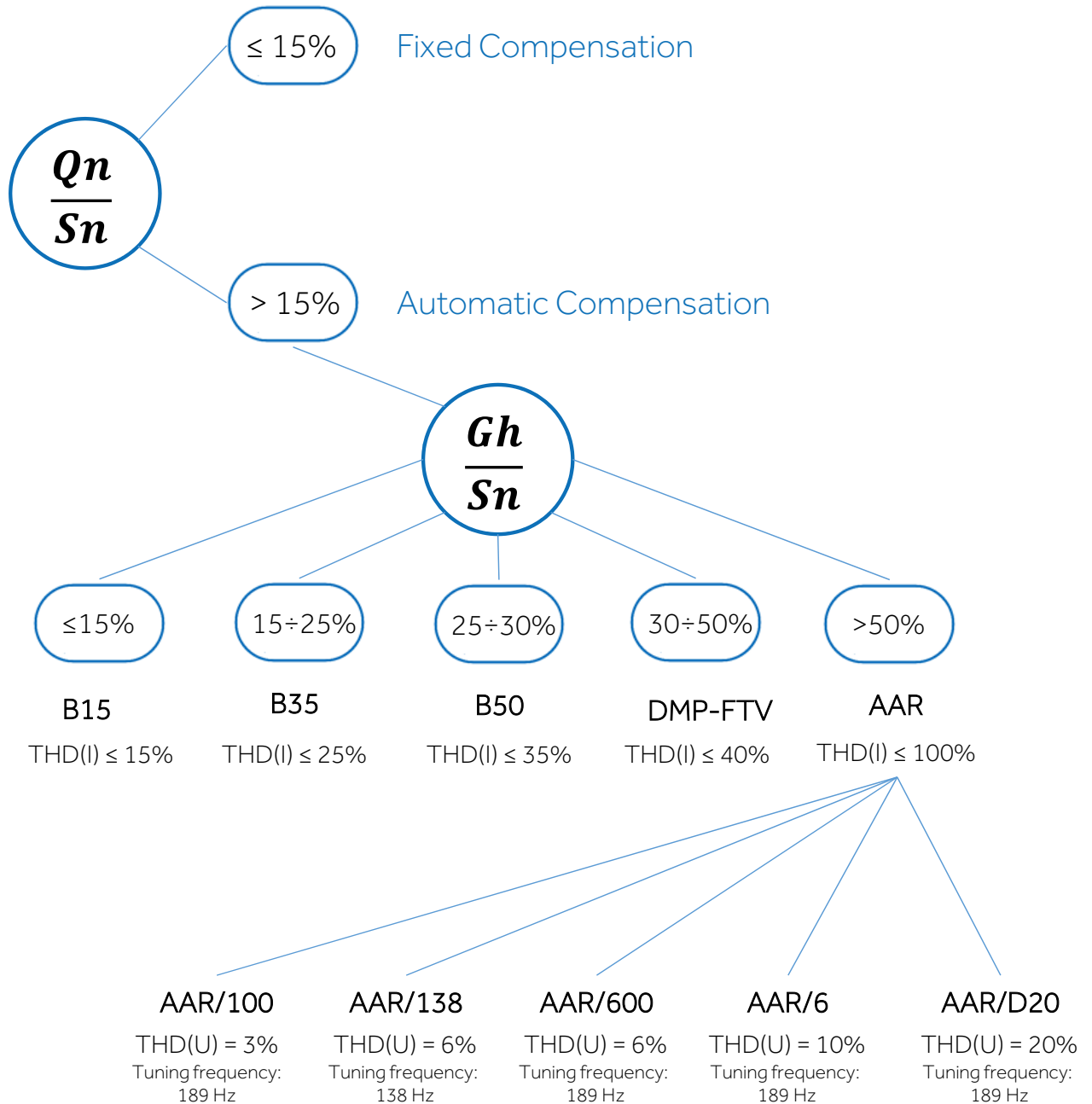

S_n = Apparent power of the transformer (kVA)

Q_n = Power of the power factor correction equipment (kvar)

G_h = Power of distorting loads (kW)

THD(I) = Maximum rate of harmonic distortion in current allowed on the network

THD(U) = Maximum rate of harmonic distortion in voltage allowed on the network

All automatic P.F.C. equipment, with or without blocking reactors, can be realized with **static insertion**, for an immediate response to load variations. The catalog contains, by way of example, the series B35 and AAR / 100.

The transformers for the distribution of electrical energy can be made in two different types: oil transformers, whose cooling does not require special aids and transformers insulated in resin, forced or natural cooled.

It is always advisable to provide for a **fixed power factor correction of the MV / LV transformers**, since even if they operate without load (for example during the night), they absorb reactive power that must be compensated.

The calculation of the necessary **capacitive power** can be performed using the approximate formula:

$$Q = I_0\% * \frac{P_n}{100}$$

I_0 = no-load current (supplied by the transformer manufacturer)

P_n = rated power of the transformer

Alternatively, if the requested data is not available, the following table can be used, differentiated by type of transformer with **normal loss** characteristics.

REACTIVE POWER* required for (NO LOAD) POWER FACTOR CORRECTION
of MV / LV TRANSFORMERS (kvar)

Transformer power (kVA)	Transformers in OIL	Transformers in RESIN
100	5	2,5
160	7,5	5
200	7,5	5
250	7,5	7,5
315	10	7,5
400	10	7,5
500	12,5	7,5
630	15	10
800	17,5	10
1000	22,5	12,5
1250	25	15
1600	30	20
2000	35	22,5
2500	45	30
3150	55	45

*indicative values

Fixed PFC of Three-phase Asynchronous Motors

One of the most common loads is the **three-phase asynchronous motor**, which can be re-phased locally, with the advantage of having the power cable run through by a lower current.

The capacitance of the capacitors must not exceed the reactive power at no load of the **motor** due to the risk of self-excitation and resonance phenomena between the capacitor and the inductance of the machine. The following table shows the power factor correction power in the case of a cage motor. For motors with wound rotor, an increase of 5% is recommended.

Rated motor power		2 poles		4 poles		6 poles		8 poles	
		3000 rpm		1500 rpm		1000 rpm		750 rpm	
HP	kW	no load	load	no load	load	no load	load	no load	load
1	0,74	0,5	0,6	0,5	0,7	0,6	0,8	0,75	1
2	1,5	0,8	1	1	1,2	1,1	1,4	1	1,5
3	2,2	1,1	1,4	1,2	1,5	1,4	1,8	1,5	2
5,5	4,1	1,7	2,2	1,9	2,5	2,1	2,8	2,5	3,5
7,5	5,5	2,3	3	2,5	3,4	2,8	3,7	3	4,5
10	7,4	3	4,4	3,6	4,6	4,1	5,4	4,5	6
15	11	4	6,5	5,5	7,2	6	8	7	9
30	22	10	12,5	11	13,5	12	15	12,5	16
50	37	17,5	24	20	27	22	30	17,5	27,5
100	74	28	45	32	49	37	54	35	55
150	110	40	64	46	70	52	76	55	80
200	150	50	81	58	89	65	95	70	105
250	180	60	98	72	105	82	115	90	130
350	257	70	113	80	130	90	146	125	185



COMAR solutions for Fixed Power factor correction



GS - CS • RFX

Fixed Power Factor Correction





The **GS** and **CS** series are specifically designed for fixed power factor correction in applications such as compensation for no-load transformers, fixed power factor correction of constant consumption. When electrical systems are affected by harmonics, CS series with blocking reactors is strongly recommended.

PERFORMANCE DATA

■ Rated voltage	415 Vac (others on request)
■ Max. voltage on capacitors (without harmonics)	450 Vac for GS-B15 series; 550 Vac for GS-B50 series; 550 Vac for CS series
■ Rated frequency	50 Hz (60 Hz on request)
■ Insulation voltage	690 Vac
■ Overvoltage	1,1 Un (rated voltage)
■ Capacitance tolerance	-5% / +10%
■ Discharge resistor	75V residual within 3 minutes (included)

QUALITY AND TESTING

Regulations IEC/EN 60831-1 / 2, IEC/EN 61921

TECHNICAL DATA

Supply	Three-phase + earth.
Degree of protection	IP 30.
Installation	Vertical. GS series : cabinet for wall mounting. CS series: cabinet for floor mounting. Indoor installation, in a well ventilated position away from heat sources.
Ventilation	GS series : natural. CS series: forced.
Dielectric losses	$\leq 0,2 \text{ W / kvar.}$
Fuses	T version only. Each capacitors bank is protected by fuses. The protection system of both the power circuits (NH-00 curve gG fuses) and the auxiliary ones (isolable fuse holders and 10.3x38 fuses) foresees the use of high breaking power fuses (100kA).
Capacitors	Single-phase capacitors in self-healing metallized polypropylene (MKP), equipped with an anti-burst device and discharge resistance. They are impregnated in vegetable oil, PCB free. Delta connection. Type of continuous service. <ul style="list-style-type: none"> • overvoltage: $1.1 \times A$ (8h / 24h) • current overload: $1.3 \times I_n$ • capacity tolerance: -5% / +10% • losses due to dissipation: $\leq 0.4 \text{ W / kvar}$ • temperature category: -25 / D

CONSTRUCTION CHARACTERISTICS

GSP-GSG-CS-GS4	fixed bank, without any protection device.
GSPT-GSGT-CST-GS4T	single battery with sectioning device (disconnecter) and protection device (fuses), suitable for power factor correction of the users.

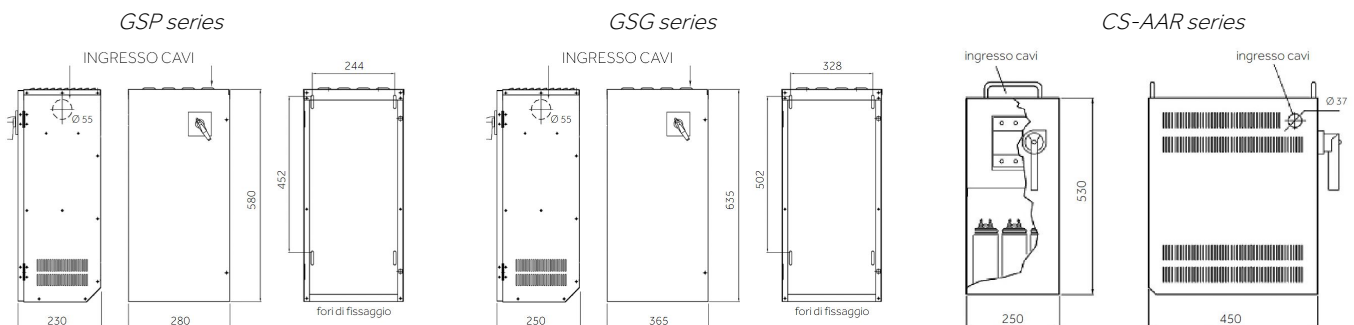

CONFIGURATION

General notes

- The cable entry is always side up;
- For the dimensions of the GS4 series, please take a look at the mechanical drawings of the cabinets, referring to the Type G4E.

Table

Code	Type	50Hz			60Hz			Capacitance μF	Weight <i>kg.</i>	THDI Max. (%)	THDlc Max. (%)	Protection device
		Qn	Un	In	Qn	Un	In					
		<i>kvar</i>	<i>V</i>	<i>A</i>	<i>kvar</i>	<i>V</i>	<i>A</i>					
8951412125325	GSP-B15	12,5	415	17	12,5	380	19	3 x 77	13	15	50	-
8951412250325	GSP-B15	25	415	35	25	380	38	3 x 154	16	15	50	-
8951412375325	GSP-B15	37,5	415	52	37,5	380	57	3 x 231	19	15	50	-
8951412500325	GSG-B15	50	415	70	50	380	76	3 x 308	21	15	50	-
8951412625325	GSG-B15	62,5	415	87	62,5	380	95	3 x 385	26	15	50	-
8951412750325	GS4-B15	75	415	104	75	380	114	3 x 462	38	15	50	-
8951413100325	GS4-B15	100	415	139	100	380	152	3 x 616	43	15	50	-
8971412125355	GSP-B50	12,5	415	17	12,5	380	19	3 x 77	15	35	80	-
8971412250355	GSP-B50	25	415	35	25	380	38	3 x 154	18	35	80	-
8971412375355	GSP-B50	37,5	415	52	37,5	380	57	3 x 231	21	35	80	-
8971412500355	GSG-B50	50	415	70	50	380	76	3 x 308	23	35	80	-
8971412625355	GSG-B50	62,5	415	87	62,5	380	95	3 x 385	28	35	80	-
8971412750355	GS4-B50	75	415	104	75	380	114	3 x 462	40	35	80	-
8971413100355	GS4-B50	100	415	139	100	380	152	3 x 616	41	35	80	-
8951413012325	GSP-B15 T	12,5	415	17	12,5	380	19	3 x 77	16	15	50	Sez+Fus 25A
8951413025325	GSP-B15 T	25	415	35	25	380	38	3 x 154	19	15	50	Sez+Fus 50A
8951413037325	GSP-B15 T	37,5	415	52	37,5	380	57	3 x 231	22	15	50	Sez+Fus 80A
8951413050325	GSG-B15 T	50	415	70	50	380	76	3 x 308	24	15	50	Sez+Fus 100A
8951413062325	GSG-B15 T	62,5	415	87	62,5	380	95	3 x 385	29	15	50	Sez+Fus 125A
8951413075325	GS4-B15 T	75	415	104	75	380	114	3 x 462	41	15	50	Sez+Fus 160A
8951414010325	GS4-B15 T	100	415	139	100	380	152	3 x 616	42	15	50	Sez+Fus 2x100A
8971413012355	GSP-B50 T	12,5	415	17	12,5	380	19	3 x 77	18	35	80	Sez+Fus 25A
8971413025355	GSP-B50 T	25	415	35	25	380	38	3 x 154	23	35	80	Sez+Fus 50A
8971413037355	GSP-B50 T	37,5	415	52	37,5	380	57	3 x 231	25	35	80	Sez+Fus 80A
8971413050355	GSG-B50 T	50	415	70	50	380	76	3 x 308	28	35	80	Sez+Fus 100A
8971413062355	GSG-B50 T	62,5	415	87	62,5	380	95	3 x 385	35	35	80	Sez+Fus 125A
8971413075355	GS4-B50 T	75	415	104	75	380	114	3 x 462	47	35	80	Sez+Fus 160A
8971414010355	GS4-B50 T	100	415	139	100	380	152	3 x 616	48	35	80	Sez+Fus 2x100A

CS series with blocking reactors:

- the dissipation losses of the inductances are 6 W / kvar (AVG);
- the max. harmonic distortion of voltage allowed in the networks is: THDU = 3% (189 Hz). Others available on request.

Code	Type	50Hz			60Hz			Capacitance <i>F</i>	Weight <i>kg.</i>	THDI Max. (%)	THDlc Max. (%)	Protection device
		Qn	Un	In	Qn	Un	In					
		<i>kvar</i>	<i>V</i>	<i>A</i>	<i>kvar</i>	<i>V</i>	<i>A</i>					
8981402125705	CS-AAR/100	12,5	400	18	13,5	380	21	3 x 77	32	100	3%	-
8981402250700	CS-AAR/100	25	400	36	27	380	41	3 x 154	41	100	3%	-
8981402500700	CS-AAR/100	50	400	72	54	380	76	3 x 308	59	100	3%	-
8981403012705	CS-AAR/100T	12,5	400	18	13,5	380	21	3 x 77	35	100	3%	Sez+Fus 25A
8981403025705	CS-AAR/100T	25	400	36	27	380	41	3 x 154	44	100	3%	Sez+Fus 50A
8981403050705	CS-AAR/100T	50	400	72	54	380	76	3 x 308	62	100	3%	Sez+Fus 100A

Version with contactor available on request.



The **RFIX** series is the new solution developed for fixed power factor correction. The compact design makes it easy to locate and install. A second version equipped with a protection device is also available.

PERFORMANCE DATA

■ Rated voltage	415 Vac (others on request)
■ Max. voltage on capacitors (without harmonics)	450 Vac for RFIX-B15 series; 550 Vac for RFIX-B50 series
■ Rated frequency	50 Hz (60 Hz on request)
■ Insulation voltage	690 Vac
■ Overvoltage	1,1 Un (rated voltage)
■ Capacitance tolerance	-5% / +10%
■ Discharge resistor	75V residual within 3 minutes (included)

QUALITY AND TESTING

Regulations IEC/EN 60831-1 / 2, IEC/EN 61921

TECHNICAL DATA

Supply	Three-phase + earth.
Degree of protection	IP 30.
Installation	Vertical, for wall mounting. Indoor installation, in a well ventilated position away from heat sources.
Ventilation	Natural.
Dielectric losses	$\leq 0,2 \text{ W / kvar}$.
Fuses	T version only. Each capacitors bank is protected by fuses. The protection system of power circuits (NH-00 curve gG fuses) foresees the use of high breaking power fuses (100kA).
Capacitors	Single-phase capacitors in self-healing metallized polypropylene (MKP), equipped with an anti-burst device and discharge resistance. They are impregnated in vegetable oil, PCB free. Delta connection. Type of continuous service. <ul style="list-style-type: none"> • overvoltage: $1.1 \times A$ (8h / 24h) • current overload: $1.3 \times I_n$ • capacity tolerance: -5% / + 10% • losses due to dissipation: $\leq 0.4 \text{ W / kvar}$ • temperature category: -25 / D

CONSTRUCTION CHARACTERISTICS

RFIX	fixed bank, without any protection device.
RFIX-T	fixed bank, equipped with protection device (isolating switch + fuses).

Fixed dimensions:

A = 170 mm
B = 400 mm
H = 250 mm

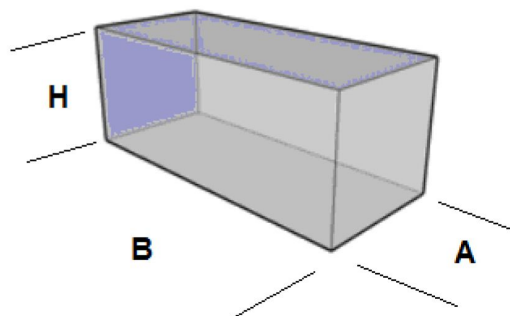

CONFIGURATION

General notes

- The cable entry is always at the top.

Table

Code	Type	50Hz			Capacitance μF	Weight <i>kg.</i>	THDI Max. (%)	THD _{ic} Max. (%)
		Qn <i>kvar</i>	Un <i>V</i>	In <i>A</i>				
8951412034335	RFIX-B15	3,4	415	4,7	3 x 21	6	15	50
8951412062335	RFIX-B15	6,25	415	8,7	3 x 38,5	6,3	15	50
8951412125335	RFIX-B15	12,5	415	17,4	3 x 77	6,5	15	50
8951412175335	RFIX-B15	17,5	415	24,3	3 x 105	7	15	50
8951412250335	RFIX-B15	25	415	34,8	3 x 154	9,5	15	50
8951412340335	RFIX-B15	34	415	48	3 x 210	10,5	15	50
8951412034350	RFIX-B50	3,4	415	4,7	3 x 21	6	35	80
8951412062350	RFIX-B50	6,25	415	8,7	3 x 38,5	6,3	35	80
8951412125350	RFIX-B50	12,5	415	17,4	3 x 77	6,5	35	80
8951412175350	RFIX-B50	17,5	415	24,3	3 x 105	7	35	80
8951412250350	RFIX-B50	25	415	34,8	3 x 154	9,5	35	80

Solution with isolator switch and fuses

Code	Type	50Hz			Capacitance μF	Weight <i>kg.</i>	THDI Max. (%)	THD _{ic} Max. (%)
		Qn <i>kvar</i>	Un <i>V</i>	In <i>A</i>				
8951412034355	RFIX-T-B15	3,4	415	4,7	3 x 21	6	15	50
8951412062355	RFIX-T-B15	6,25	415	8,7	3 x 38,5	6,3	15	50
8951412125355	RFIX-T-B15	12,5	415	17,4	3 x 77	6,5	15	50
8951412175355	RFIX-T-B15	17,5	415	24,3	3 x 105	7	15	50
8951412250355	RFIX-T-B15	25	415	34,8	3 x 154	9,5	15	50
8951412340355	RFIX-T-B15	34	415	48	3 x 210	10,5	15	50
8951412034375	RFIX-T-B50	3,4	415	4,7	3 x 21	6	35	80
8951412062375	RFIX-T-B50	6,25	415	8,7	3 x 38,5	6,3	35	80
8951412125375	RFIX-T-B50	12,5	415	17,4	3 x 77	6,5	35	80
8951412175375	RFIX-T-B50	17,5	415	24,3	3 x 105	7	35	80
8951412250375	RFIX-T-B50	25	415	34,8	3 x 154	9,5	35	80

Other solutions are available on request.

Discover our **Academy** and its **Insights**:

- Harmonics and Power Factor Correction
- Advantages of dielectric in MKP capacitors
- Housing and filling PFC capacitors



www.comarcond.com



Welcome to the **ACADEMY** of COMAR Condensatori:

here is where we share our solutions for Power Factor Correction, Harmonic Filtering and our technology for the production of Polypropylene Film Capacitors.

Technical Guides



Photovoltaic plant and Power Factor Correction

Photovoltaic plant and Power Factor Correction

Choice of Power Factor Correction equipment in the presence of Harmonics

Choice of Power Factor Correction equipment in the presence of Harmonics

Check and Replacement of PFC Capacitors

Check and Replacement of PFC Capacitors

Photovoltaic plant and Power Factor Correction

Photovoltaic plant and Power Factor Correction

Videos



Power Factor Correction remote monitoring | COMAR Condensatori

Power Factor Correction remote monitoring | COMAR Condensatori

DOWNLOAD VIDEO

CCS Tutorial | COMAR Condensatori

CCS Tutorial | COMAR Condensatori

DOWNLOAD VIDEO

Installation of Power Factor Correction equipment | COMAR Condensatori (English sub)

Installation of Power Factor Correction equipment | COMAR Condensatori (English sub)

DOWNLOAD VIDEO

Maintenance of Power Factor Correction equipment | COMAR Condensatori (English sub)

Maintenance of Power Factor Correction equipment | COMAR Condensatori (English sub)

DOWNLOAD VIDEO

Articles & Insights



Harmonics and Power Factor Correction

Harmonics and Power Factor Correction

DOWNLOAD ARTICLE

Advantages of dielectric in MKP capacitors

Advantages of dielectric in MKP capacitors

DOWNLOAD ARTICLE

PFC of a wire drawing manufacturer (case study)

PFC of a wire drawing manufacturer (case study)

DOWNLOAD ARTICLE

Fixed PFC of Transformers and Motors

Fixed PFC of Transformers and Motors

DOWNLOAD ARTICLE



GE 230V • B15 • B35 • B50 • DMP-FTV

Automatic Power Factor Correction



GE 230V

Automatic Power Factor Correction equipment



GE 230V series is particularly suitable for three-phase networks with **low harmonic distortion** in current. These equipment guarantee an accurate power factor correction, thanks to a multi-step design that effectively divides the power. In addition, on the G6E cabinet, all the capacitors banks are assembled on racks, easily removable from the front of the panel, for simple management and maintenance.

PERFORMANCE DATA

■ Rated voltage	230 Vac (others on request)
■ Rated frequency	50 Hz (60 Hz on request)
■ Insulation voltage	690 Vac
■ Auxiliary voltage	230 Vac (110 Vac on request)
■ Overvoltage	1,1 Un (rated voltage)
■ Temperature range	-5 / +40 °C
■ Impulse withstand	6 kV (G3E, G4E); 8 kV (G4RM, G6E)

HARMONIC CONTENT (in the absence of resonance)

THD(I)max. = 15%	on the network
THD(Ic)max. = 50%	on the capacitors

TECHNICAL DATA

Enclosures	Made of sheet steel, protected against corrosion by phosphating and epoxy powder coating. RAL 7032 colour (others on request). Degree of protection: external panel IP 31, with the exception of type G3E and G4E with IP30 (others on request); internal panel IP 20 at the input of power cables (IP 20 with open doors on request).
Installation	Indoor installation, in a well ventilated position away from heat sources.
Ventilation	Natural for powers up to 95 kvar; Forced for powers over 95 kvar.
Switch isolator	Tri-polar under-load type with door lock.
Wiring	The internal connection cables are FS17-450 / 750V type, flame retardant and with very low fumes emission (other types of cables on request). On the non-pre-insulated terminals the connection point is covered with a long-life heat-shrinking sheath. The auxiliary voltage are appropriately identified in compliance with current regulations.
3-pole contactors	Each battery is switched on / off by a three-pole contactor (Class AC6-b) to offer high reliability. The limitation of current peaks caused by the insertion of the capacitive batteries is guaranteed by pre-charging resistors.
Fuses	Each capacitors bank is protected by fuses. The protection system of both the power circuits (NH-00 curve gG fuses) and the auxiliary ones (isolable fuse holders and 10.3x38 fuses) foresees the use of high breaking power fuses (100kA).
Capacitors	Single-phase capacitors in self-healing metallized polypropylene (MKP), equipped with an anti-burst device and discharge resistance. They are impregnated in vegetable oil, PCB free. Delta connection. Type of continuous service. <ul style="list-style-type: none">• rated voltage: 250 Vac (maximum voltage 275 Vac)• overvoltage: 1.1 x A (8h / 24h)• current overload: 1.3 x In• capacity tolerance: -5% / + 10%• losses due to dissipation: ≤0.4 W / kvar• temperature category: -25 / D
Controller	<ul style="list-style-type: none">• type of measurement: varmetric.• amperometric signal: by means of an amperometric transformer with secondary 5A, class 1 - 5VA (by the user)• amperometric signal sensitivity: 2.5% for BMR series, 0.3% for HPR series• standard capacitors on / off times: 25 "÷ 30" (others on request)

QUALITY AND TESTING

Regulations	Capacitors: IEC/EN 60831-1 / 2 certified by IMQ (V1927); Equipment: IEC/EN 61439-1 / 2, IEC/EN 61921.
European directives	Low voltage: 2014/35/CE; Electromagnetic compatibility: 2014/30/CE.
Testing	100% of the automatic equipment is subject to visual inspection, insulation test: phase-phase and phase-earth, battery efficiency and ventilation circuit control: the report is included in the documentation. The capacitors are tested in three consecutive stages of the production process: after winding, regeneration and before labeling.

CONFIGURATION

General notes

- For dimensions, please consult the cabinet drawings, referring to the "Type" column.
- The indication for cable entry (power supply) is as follows: ↑ from the bottom, ✓ side up, ↓ from the top
- The rated power is expressed at 230 V - 50 Hz.

The choice of supply cables depends on the installation conditions, the length of the same and the ambient temperature. For a correct sizing, refer to the IEC 60364-5, CEI 64-8 and the UNEL 35024/01 standards.

Cloud Control System (CCS)



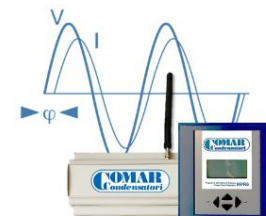

The symbol  indicates that CCS, the remote monitoring system, is pre-installed on the P.F.C. equipment. For any specific information, and to find out the advantages of the Cloud Control System service, refer to the appropriate brochure available on www.comarcond.com or directly on request.



Table

THD(I)max. = 15%

THD(Ic)max. = 50%

Code	Type	Qn	Cable entry	In		Banks size				Steps (n)	Switch isolator (A)	Controller (type)	CCS	Weight (kg)	
		(kvar)		(A)	(kvar)										
8571232125108	G3E	12,5	✓	31	2,5	5	5			5	80	BMR6		16	
8571232175100	G3E	17,5	✓	44	2,5	5	10			7	80	BMR6		23	
8571232250100	G3E	25	✓	62	5	10	10			5	125	BMR6		26	
8571232375108	G4E	37,5	✓	94	2,5	5	10	20		15	200	BMR6		46	
8571232550208	G4RM	55	✓	138	5	10	20	20		11	200	BMR6		89	
8571232750208	G4RM	75	✓	188	5	10	10	10	20	20	15	315	BMR6		95
8571232950208	G4RM	95	✓	238	5	10	20	20	20	20	19	400	BMR6		102
8571233115209	G6E	115	↓	288	5	10	20	20	20	40	23	500	HPR6		175
8571233140209	G6E	140	↓	351	10	10	20	20	40	40	14	630	HPR6		192
8571233160209	G6E	160	↓	401	20	20	20	20	40	40	8	630	HPR6		207
8571233180209	G6E	180	↓	452	20	20	20	40	40	40	10	800	HPR6		240
8571233200209	G6E	200	↓	502	20	20	40	40	40	40	10	800	HPR6		255

Other solutions are available on request.



B15 series equipment are particularly suitable for three-phase networks with operating voltage equal to 400 Vac (+/- 10%) with low harmonic distortion in current. These equipment guarantee an accurate P.F.C., thanks to a multi-step design that effectively divides the power. In addition, on the G6E and G8E cabinet, all the capacitors banks are assembled on racks, easily removable from the front of the panel, for simple management and maintenance.

PERFORMANCE DATA

■ Rated voltage	415 Vac (others on request)
■ Rated frequency	50 Hz (60 Hz on request)
■ Insulation voltage	690 Vac
■ Auxiliary voltage	400 Vac for G3E, G4E, G4RM ¹ 230 Vac for G4RM ² , G6E, G8E
■ Overvoltage	1,1 Un (rated voltage)
■ Temperature range	-5 / +40 °C
■ Impulse withstand	6 kV (G3E, G4E); 8 kV (G4RM, G6E, G8E)

¹up to 200 kvar. ²over 200 kvar. Auxiliary voltage is supplied by a proper transformer.

HARMONIC CONTENT (in the absence of resonance)

THD(I)max. = 15%	on the network
THD(Ic)max. = 50%	on the capacitors

TECHNICAL DATA

Enclosures	Made of sheet steel, protected against corrosion by phosphating and epoxy powder coating. RAL 7032 colour (others on request). Degree of protection: external panel IP 31, with the exception of type G3E and G4E with IP30 (others on request); internal panel IP 20 at the input of power cables (IP 20 with open doors on request).
Installation	Indoor installation, in a well ventilated position away from heat sources.
Ventilation	Natural for powers up to 200 kvar; Forced for powers over 200 kvar.
Switch isolator	Tri-polar under-load type with door lock.
Wiring	The internal connection cables are FS17-450 / 750V type, flame retardant and with very low fumes emission (other types of cables on request). On the non-pre-insulated terminals the connection point is covered with a long-life heat-shrinking sheath. The auxiliary voltage are appropriately identified in compliance with current regulations.
3-pole contactors	Each battery is switched on / off by a three-pole contactor (Class AC6-b) to offer high reliability. The limitation of current peaks caused by the insertion of the capacitive batteries is guaranteed by pre-charging resistors.
Fuses	Each capacitors bank is protected by fuses. The protection system of both the power circuits (NH-00 curve gG fuses) and the auxiliary ones (isolable fuse holders and 10.3x38 fuses) foresees the use of high breaking power fuses (100kA).
Capacitors	Single-phase capacitors in self-healing metallized polypropylene (MKP), equipped with an anti-burst device and discharge resistance. They are impregnated in vegetable oil, PCB free. Delta connection. Type of continuous service. <ul style="list-style-type: none"> • rated voltage: 415 Vac (maximum voltage 450 Vac) • overvoltage: 1.1 x A (8h / 24h) • current overload: 1.3 x In • capacity tolerance: -5% / + 10% • losses due to dissipation: ≤0.4 W / kvar • temperature category: -25 / D
Controller	<ul style="list-style-type: none"> • type of measurement: varmetric. • amperometric signal: by means of an amperometric transformer with secondary 5A, class 1 - 5VA (by the user) • amperometric signal sensitivity: 2.5% for BMR series, 0.3% for HPR series • standard capacitors on / off times: 25 "÷ 30" (others on request)

QUALITY AND TESTING

Regulations	Capacitors: IEC/EN 60831-1 / 2 certified by IMQ (V1927); Equipment: IEC/EN 61439-1 / 2, IEC/EN 61921.
European directives	Low voltage: 2014/35/CE; Electromagnetic compatibility: 2014/30/CE.
Testing	100% of the automatic equipment is subject to visual inspection, insulation test: phase-phase and phase-earth, battery efficiency and ventilation circuit control: the report is included in the documentation. The capacitors are tested in three consecutive stages of the production process: after winding, regeneration and before labeling.

CONFIGURATION

General notes

- For dimensions, please consult the cabinet drawings, referring to the "Type" column.
- The indication for cable entry (power supply) is as follows: ↑ from the bottom, ✓ side up, ↓ from the top
- The rated power is expressed at 415 V - 50 Hz.

The choice of supply cables depends on the installation conditions, the length of the same and the ambient temperature. For a correct sizing, refer to the IEC 60364-5, CEI 64-8 and the UNEL 35024/01 standards.

Cloud Control System (CCS)



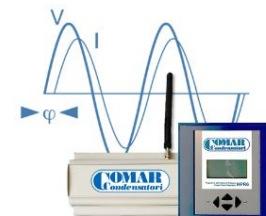











The symbol  indicates that CCS, the remote monitoring system, is pre-installed on the P.F.C. equipment. For any specific information, and to find out the advantages of the Cloud Control System service, refer to the appropriate brochure available on www.comarcond.com or directly on request.



Table

THD(I)max. = 15%

THD(Ic)max. = 50%

Code	Type	Qn (kvar)	Cable entry	In (A)	Banks size (kvar)				Steps (n)	Switch isolator (A)	Controller (type)	CCS	Weight (kg)			
8631412102320	G3E	10,2	✓	14	3,4	3,4	3,4		3	40	BMR4		14			
8631412159320	G3E	15,9	✓	22	3,4	6,25	6,25		5	40	BMR4		15			
8631412221320	G3E	22,15	✓	31	3,4	6,25	12,5		7	80	BMR4		16			
8631412310320	G3E	31,25	✓	43	6,25	12,5	12,5		5	80	BMR4		18			
8631412435320	G3E	43,75	✓	61	6,25	12,5	25		7	125	BMR4		22			
8631412500320	G3E	50	✓	70	12,5	12,5	25		4	125	BMR4		23			
8631412625320	G3E	62,5	✓	87	12,5	25	25		5	125	BMR4		26			
8631412750320	G4E	75	✓	104	12,5	12,5	25	25	6	160	BMR4		38			
8631413100400	G4E	100	✓	139	12,5	12,5	25	50	8	200	BMR4		43			
8631413125325	G4RM	125	✓	174	25	50	50		5	250	BMR4		80			
8661413150325	G4RM	150	✓	209	25	25	50	50	6	315	BMR4		85			
8661413175325	G4RM	175	✓	243	25	50	50	50	7	400	BMR4		87			
8661413200325	G4RM	200	✓	278	25	25	50	100	8	400	BMR4		89			
8661413225325	G4RM	225	✓	313	25	50	50	100	9	500	BMR4		95			
8661413250325	G4RM	250	✓	348	25	50	75	100	10	500	BMR4		102			
8661413300325	G6E	300	↓	417	25	50	75	75	75	12	630	HPR6		175		
8661413350325	G6E	350	↓	487	50	75	75	75	75	9	800	HPR6		192		
8661413400325	G6E	400	↓	556	50	50	75	75	75	75	14	800	HPR6		207	
8661413450325	G6E	450	↓	626	50	50	50	75	75	150	16	1000	HPR6		240	
8661413500325	G6E	500	↓	696	50	75	75	75	75	150	13	1000	HPR6		255	
8631413525420	G8E	525	↑	731	75	75	75	75	75	75	7	1250	HPR12		315	
8631413600420	G8E	600	↑	836	75	75	75	75	75	75	75	8	1250	HPR12		330
8631413675420	G8E	675	↑	940	75	75	75	75	75	75	150	9	1250	HPR12		350
8631413750420	G8E	750	↑	1045	75	75	75	75	75	150	150	10	1600	HPR12		380
8631413825420	G8E (II)	825	↑	1149	75	75	75	75	75	150	150	11	800+1000	HPR12		510
8631413900420	G8E (II)	900	↑	1254	75	75	75	75	150	150	150	12	1000+1000	HPR12		530
8631413975420	G8E (II)	975	↑	1358	75	75	75	150	150	150	150	13	1000+1000	HPR12		550
8631414105420	G8E (II)	1050	↑	1462	75	75	150	150	150	150	150	14	1000+1000	HPR12		650
8631414120420	G8E (II)	1200	↑	1671	75	75	150	150	150	150	300	16	1250+1250	HPR12		690
8631414135420	G8E (II)	1350	↑	1880	75	75	150	150	150	150	300	18	1250+1250	HPR12		730

Other solutions are available on request.



B35 series equipment are particularly suitable for three-phase networks with operating voltage equal to 400 Vac (+/- 10%) with low-medium harmonic distortion in current. These equipment guarantee an accurate P.F.C., thanks to a multi-step design that effectively divides the power. In addition, on the G6E and G8E cabinet, all the capacitors banks are assembled on racks, easily removable from the front of the panel, for simple management and maintenance.

PERFORMANCE DATA

■ Rated voltage	415 Vac (others on request)
■ Rated frequency	50 Hz (60 Hz on request)
■ Insulation voltage	690 Vac
■ auxiliary voltage	400 Vac for G3E, G4E, G4RM ¹ 230 Vac for G4RM ² , G6E, G8E
■ Overvoltage	1,1 Un (rated voltage)
■ Temperature range	-5 / +40 °C
■ Impulse withstand	6 kV (G3E, G4E); 8 kV (G4RM, G6E, G8E)

¹up to 200 kvar. ²over 200 kvar. Auxiliary voltage is supplied by a proper transformer.

HARMONIC CONTENT (in the absence of resonance)

THD(I)max. = 25%	on the network
THD(Ic)max. = 70%	on the capacitors

TECHNICAL DATA

Enclosures	Made of sheet steel, protected against corrosion by phosphating and epoxy powder coating. RAL 7032 colour (others on request). Degree of protection: external panel IP 31, with the exception of type G3E and G4E with IP30 (others on request); internal panel IP 20 at the input of power cables (IP 20 with open doors on request).
Installation	Indoor installation, in a well ventilated position away from heat sources.
Ventilation	Natural for powers up to 200 kvar; Forced for powers over 200 kvar.
Switch isolator	Tri-polar under-load type with door lock.
Wiring	The internal connection cables are FS17-450 / 750V type, flame retardant and with very low fumes emission (other types of cables on request). On the non-pre-insulated terminals the connection point is covered with a long-life heat-shrinking sheath. The auxiliary voltage are appropriately identified in compliance with current regulations.
3-pole contactors	Each battery is switched on / off by a three-pole contactor (Class AC6-b) to offer high reliability. The limitation of current peaks caused by the insertion of the capacitive batteries is guaranteed by pre-charging resistors.
Fuses	Each capacitors bank is protected by fuses. The protection system of both the power circuits (NH-00 curve gG fuses) and the auxiliary ones (isolable fuse holders and 10.3x38 fuses) foresees the use of high breaking power fuses (100kA).
Capacitors	Single-phase capacitors in self-healing metallized polypropylene (MKP), equipped with an anti-burst device and discharge resistance. They are impregnated in vegetable oil, PCB free. Delta connection. Type of continuous service. <ul style="list-style-type: none"> • rated voltage: 440 Vac (maximum voltage 500 Vac) • overvoltage: 1.1 x A (8h / 24h) • current overload: 1.3 x In • capacity tolerance: -5% / + 10% • losses due to dissipation: ≤0.4 W / kvar • temperature category: -25 / D
Controller	<ul style="list-style-type: none"> • type of measurement: varmetric. • amperometric signal: by means of an amperometric transformer with secondary 5A, class 1 - 5VA (by the user) • amperometric signal sensitivity: 2.5% for BMR series, 0.3% for HPR series • standard capacitors on / off times: 25 "÷ 30" (others on request)

QUALITY AND TESTING

Regulations	Capacitors: IEC/EN 60831-1 / 2 certified by IMQ (V1927); Equipment: IEC/EN 61439-1 / 2, IEC/EN 61921.
European directives	Low voltage: 2014/35/CE; Electromagnetic compatibility: 2014/30/CE.
Testing	100% of the automatic equipment is subject to visual inspection, insulation test: phase-phase and phase-earth, battery efficiency and ventilation circuit control: the report is included in the documentation. The capacitors are tested in three consecutive stages of the production process: after winding, regeneration and before labeling.

CONFIGURATION

General notes

- For dimensions, please consult the cabinet drawings, referring to the "Type" column.
- The indication for cable entry (power supply) is as follows: ↑ from the bottom, ↙ side up, ↓ from the top
- The rated power is expressed at 415 V - 50 Hz.

The choice of supply cables depends on the installation conditions, the length of the same and the ambient temperature. For a correct sizing, refer to the IEC 60364-5, CEI 64-8 and the UNEL 35024/01 standards.

Cloud Control System (CCS)



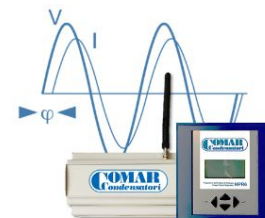











The symbol  indicates that CCS, the remote monitoring system, is pre-installed on the P.F.C. equipment. For any specific information, and to find out the advantages of the Cloud Control System service, refer to the appropriate brochure available on www.comarcond.com or directly on request.



Table

THD(I)max. = 25%

THD(Ic)max. = 70%

Code	Type	Qn (kvar)	Cable entry	In (A)				Banks size (kvar)				Steps (n)	Switch isolator (A)	Controlle r (type)	CCS	Weight (kg)
				14	3,4	3,4	3,4	3,4	6,25	6,25	6,25					
8671412102340	G3E	10,2	↙	14	3,4	3,4	3,4				3	40	BMR4		14	
8671412159340	G3E	15,9	↙	22	3,4	6,25	6,25				5	40	BMR4		15	
8671412221340	G3E	22,15	↙	31	3,4	6,25	12,5				7	80	BMR4		16	
8671412310340	G3E	31,25	↙	43	6,25	12,5	12,5				5	80	BMR4		18	
8671412435340	G3E	43,75	↙	61	6,25	12,5	25				7	125	BMR4		22	
8671412500340	G3E	50	↙	70	12,5	12,5	25				4	125	BMR4		23	
8671412625340	G3E	62,5	↙	87	12,5	25	25				5	125	BMR4		26	
8671412750340	G4E	75	↙	104	12,5	12,5	25	25			6	160	BMR4		38	
8671413100340	G4E	100	↙	139	12,5	12,5	25	50			8	200	BMR4		43	
8671413125345	G4RM	125	↙	174	25	50	50				5	250	BMR4		80	
8671413150345	G4RM	150	↙	209	25	25	50	50			6	315	BMR4		85	
8671413175345	G4RM	175	↙	243	25	50	50	50			7	400	BMR4		87	
8671413200345	G4RM	200	↙	278	25	25	50	100			8	400	BMR4		89	
8671413225345	G4RM	225	↙	313	25	50	50	100			9	500	BMR4		95	
8671413250345	G4RM	250	↙	348	25	50	75	100			10	500	BMR4		102	
8671413300355	G6E	300	↓	417	25	50	75	75	75		12	630	HPR6		175	
8671413350355	G6E	350	↓	487	50	75	75	75	75		9	800	HPR6		192	
8671413400355	G6E	400	↓	556	50	50	75	75	75	75	14	800	HPR6		207	
8671413450355	G6E	450	↓	626	50	50	50	75	75	150	16	1000	HPR6		240	
8671413500355	G6E	500	↓	696	50	75	75	75	75	150	13	1000	HPR6		255	
8671413525440	G8E	525	↑	731	75	75	75	75	75	75	7	1250	HPR12		315	
8671413600440	G8E	600	↑	836	75	75	75	75	75	75	8	1250	HPR12		330	
8671413675440	G8E	675	↑	940	75	75	75	75	75	75	150	9	1250	HPR12		350
8671413750440	G8E	750	↑	1045	75	75	75	75	75	150	150	10	1600	HPR12		380
8671413825440	G8E (II)	825	↑	1149	75	75	75	75	75	150	150	11	800+1000	HPR12		510
8671413900440	G8E (II)	900	↑	1254	75	75	75	75	150	150	150	12	1000+1000	HPR12		530
8671413975440	G8E (II)	975	↑	1358	75	75	75	150	150	150	150	13	1000+1000	HPR12		550
8671414105440	G8E (II)	1050	↑	1462	75	75	150	150	150	150	150	14	1000+1000	HPR12		650
8671414120440	G8E (II)	1200	↑	1671	75	75	150	150	150	150	300	16	1250+1250	HPR12		690
8671414135440	G8E (II)	1350	↑	1880	75	75	150	150	150	300	300	18	1250+1250	HPR12		730

Other solutions are available on request.



B50 series equipment are particularly suitable for three-phase networks with operating voltage equal to 400 Vac (+/- 10%) with medium harmonic distortion in current. These equipment guarantee an accurate P.F.C., thanks to a multi-step design that effectively divides the power. In addition, on the G6E and G8E cabinet, all the capacitors banks are assembled on racks, easily removable from the front of the panel, for simple management and maintenance.

PERFORMANCE DATA

■ Rated voltage	415 Vac (others on request)
■ Rated frequency	50 Hz (60 Hz on request)
■ Insulation voltage	690 Vac
■ auxiliary voltage	400 Vac for G3E, G4E, G4RM ¹ 230 Vac for G4RM ² , G6E, G8E
■ Overvoltage	1,1 Un (rated voltage)
■ Temperature range	-5 / +40 °C
■ Impulse withstand	6 kV (G3E, G4E); 8 kV (G4RM, G6E, G8E)

¹up to 200 kvar. ²over 200 kvar. Auxiliary voltage is supplied by a proper transformer.

HARMONIC CONTENT (in the absence of resonance)

THD(I)max. = 35%	on the network
THD(Ic)max. = 80%	on the capacitors

TECHNICAL DATA

Enclosures	Made of sheet steel, protected against corrosion by phosphating and epoxy powder coating. RAL 7032 colour (others on request). Degree of protection: external panel IP 31, with the exception of type G3E and G4E with IP30 (others on request); internal panel IP 20 at the input of power cables (IP 20 with open doors on request).
Installation	Indoor installation, in a well ventilated position away from heat sources.
Ventilation	Natural for powers up to 200 kvar; Forced for powers over 200 kvar.
Switch isolator	Tri-polar under-load type with door lock.
Wiring	The internal connection cables are FS17-450 / 750V type, flame retardant and with very low fumes emission (other types of cables on request). On the non-pre-insulated terminals the connection point is covered with a long-life heat-shrinking sheath. The auxiliary voltage are appropriately identified in compliance with current regulations.
3-pole contactors	Each battery is switched on / off by a three-pole contactor (Class AC6-b) to offer high reliability. The limitation of current peaks caused by the insertion of the capacitive batteries is guaranteed by pre-charging resistors.
Fuses	Each capacitors bank is protected by fuses. The protection system of both the power circuits (NH-00 curve gG fuses) and the auxiliary ones (isolable fuse holders and 10.3x38 fuses) foresees the use of high breaking power fuses (100kA).
Capacitors	Single-phase capacitors in self-healing metallized polypropylene (MKP), equipped with an anti-burst device and discharge resistance. They are impregnated in vegetable oil, PCB free. Delta connection. Type of continuous service. <ul style="list-style-type: none"> • rated voltage: 500 Vac (maximum voltage 550 Vac) • overvoltage: 1.1 x A (8h / 24h) • current overload: 1.3 x In • capacity tolerance: -5% / + 10% • losses due to dissipation: ≤0.4 W / kvar • temperature category: -25 / D
Controller	<ul style="list-style-type: none"> • type of measurement: varmetric. • amperometric signal: by means of an amperometric transformer with secondary 5A, class 1 - 5VA (by the user) • amperometric signal sensitivity: 2.5% for BMR series, 0.3% for HPR series • standard capacitors on / off times: 25 "÷ 30" (others on request)

QUALITY AND TESTING

Regulations	Capacitors: IEC/EN 60831-1 / 2 certified by IMQ (V1927); Equipment: IEC/EN 61439-1 / 2, IEC/EN 61921.
European directives	Low voltage: 2014/35/CE; Electromagnetic compatibility: 2014/30/CE.
Testing	100% of the automatic equipment is subject to visual inspection, insulation test: phase-phase and phase-earth, battery efficiency and ventilation circuit control: the report is included in the documentation. The capacitors are tested in three consecutive stages of the production process: after winding, regeneration and before labeling.

CONFIGURATION

General notes

- For dimensions, please consult the cabinet drawings, referring to the "Type" column.
- The indication for cable entry (power supply) is as follows: ↑ from the bottom, ✓ side up, ↓ from the top
- The rated power is expressed at 415 V - 50 Hz.

The choice of supply cables depends on the installation conditions, the length of the same and the ambient temperature. For a correct sizing, refer to the IEC 60364-5, CEI 64-8 and the UNEL 35024/01 standards.

Cloud Control System (CCS)















The symbol  indicates that CCS, the remote monitoring system, is pre-installed on the P.F.C. equipment. For any specific information, and to find out the advantages of the Cloud Control System service, refer to the appropriate brochure available on www.comarcond.com or directly on request.



Table

THD(I)max. = 35%

THD(Ic)max. = 80%

Code	Type	Qn (kvar)	Cable entry	In (A)	Banks size (kvar)				Steps (n)	Switch isolator (A)	Controller (type)	CCS	Weight (kg)				
8681412102350	G3E	10,2	✓	14	3,4	3,4	3,4		3	40	BMR4		14				
8681412159350	G3E	15,9	✓	22	3,4	6,25	6,25		5	40	BMR4		15				
8681412221350	G3E	22,15	✓	31	3,4	6,25	12,5		7	80	BMR4		16				
8681412310350	G3E	31,25	✓	43	6,25	12,5	12,5		5	80	BMR4		18				
8681412435350	G3E	43,75	✓	61	6,25	12,5	25		7	125	BMR4		22				
8681412500350	G3E	50	✓	70	12,5	12,5	25		4	125	BMR4		23				
8681412625350	G3E	62,5	✓	87	12,5	25	25		5	125	BMR4		26				
8681412750350	G4E	75	✓	104	12,5	12,5	25	25	6	160	BMR4		38				
8681413100350	G4E	100	✓	139	12,5	12,5	25	50	8	200	BMR4		43				
8681413125355	G4RM	125	✓	174	25	50	50		5	250	BMR4		80				
8681413150355	G4RM	150	✓	209	25	25	50	50	6	315	BMR4		85				
8681413175355	G4RM	175	✓	243	25	50	50	50	7	400	BMR4		87				
8681413200355	G4RM	200	✓	278	25	25	50	100	8	400	BMR4		89				
8681413225355	G4RM	225	✓	313	25	50	50	100	9	500	BMR4		95				
8681413250355	G4RM	250	✓	348	25	50	75	100	10	500	BMR4		102				
8681413300345	G6E	300	↓	417	25	50	75	75	75	12	630	HPR6		175			
8681413350345	G6E	350	↓	487	50	75	75	75	75	9	800	HPR6		192			
8681413400345	G6E	400	↓	556	50	50	75	75	75	75	14	800	HPR6		207		
8681413450345	G6E	450	↓	626	50	50	50	75	75	150	16	1000	HPR6		240		
8681413500345	G6E	500	↓	696	50	75	75	75	75	150	13	1000	HPR6		255		
8681413525450	G8E	525	↑	731	75	75	75	75	75	75	7	1250	HPR12		315		
8681413600450	G8E	600	↑	836	75	75	75	75	75	75	75	8	1250	HPR12		330	
8681413675450	G8E	675	↑	940	75	75	75	75	75	75	150	9	1250	HPR12		350	
8681413750450	G8E	750	↑	1045	75	75	75	75	75	75	150	150	10	1600	HPR12		380
8681413825450	G8E (III)	825	↑	1149	75	75	75	75	150	150	150	11	800+1000	HPR12		510	
8681413900450	G8E (III)	900	↑	1254	75	75	75	75	150	150	150	12	1000+1000	HPR12		530	
8681413975450	G8E (III)	975	↑	1358	75	75	75	150	150	150	150	13	1000+1000	HPR12		550	
8681414105450	G8E (III)	1050	↑	1462	75	75	150	150	150	150	150	14	1000+1000	HPR12		650	
8681414120450	G8E (III)	1200	↑	1671	75	75	150	150	150	150	300	16	1250+1250	HPR12		690	
8681414135450	G8E (III)	1350	↑	1880	75	75	150	150	150	150	300	300	18	1250+1250	HPR12		730

Other solutions are available on request.

DMP-FTV

Automatic Power Factor Correction equipment



DMP-FTV series equipment are particularly suitable for three-phase networks with operating voltage equal to 400 Vac (+/- 10%) with medium-high harmonic distortion in current. These equipment guarantee an accurate P.F.C., thanks to a multi-step design that effectively divides the power. In addition, on the G6E and G8E cabinet, all the capacitors banks are assembled on racks, easily removable from the front of the panel, for simple management and maintenance.

PERFORMANCE DATA

■ Rated voltage	415 Vac (others on request)
■ Rated frequency	50 Hz (60 Hz on request)
■ Insulation voltage	690 Vac
■ auxiliary voltage	400 Vac for G3E, G4E, G4RM ¹ 230 Vac for G4RM ² , G6E, G8E
■ Overvoltage	1,1 Un (rated voltage)
■ Temperature range	-5 / +40 °C
■ Impulse withstand	6 kV (G3E, G4E); 8 kV (G4RM, G6E, G8E)

¹up to 200 kvar. ²over 200 kvar. Auxiliary voltage is supplied by a proper transformer.

HARMONIC CONTENT (in the absence of resonance)

THD(I)max. = 40%	on the network
THD(Ic)max. = 90%	on the capacitors

TECHNICAL DATA

Enclosures	Made of sheet steel, protected against corrosion by phosphating and epoxy powder coating. RAL 7032 colour (others on request). Degree of protection: external panel IP 31, with the exception of type G3E and G4E with IP30 (others on request); internal panel IP 20 at the input of power cables (IP 20 with open doors on request).
Installation	Indoor installation, in a well ventilated position away from heat sources.
Ventilation	Natural for powers up to 200 kvar; Forced for powers over 200 kvar.
Switch isolator	Tri-polar under-load type with door lock.
Wiring	The internal connection cables are FS17-450 / 750V type, flame retardant and with very low fumes emission (other types of cables on request). On the non-pre-insulated terminals the connection point is covered with a long-life heat-shrinking sheath. The auxiliary voltage are appropriately identified in compliance with current regulations.
3-pole contactors	Each battery is switched on / off by a three-pole contactor (Class AC6-b) to offer high reliability. The limitation of current peaks caused by the insertion of the capacitive batteries is guaranteed by pre-charging resistors.
Fuses	Each capacitors bank is protected by fuses. The protection system of both the power circuits (NH-00 curve gG fuses) and the auxiliary ones (isolable fuse holders and 10.3x38 fuses) foresees the use of high breaking power fuses (100kA).
Capacitors	Single-phase capacitors in self-healing metallized polypropylene (MKP), equipped with an anti-burst device and discharge resistance. They are impregnated in vegetable oil, PCB free. Delta connection. Type of continuous service. <ul style="list-style-type: none">• rated voltage: 600 Vac (maximum voltage 660 Vac)• overvoltage: 1.1 x A (8h / 24h)• current overload: 1.3 x In• capacity tolerance: -5% / + 10%• losses due to dissipation: ≤0.4 W / kvar• temperature category: -25 / D
Controller	<ul style="list-style-type: none">• type of measurement: varmetric.• amperometric signal: by means of an amperometric transformer with secondary 5A, class 1 - 5VA (by the user)• amperometric signal sensitivity: 2.5% for BMR series, 0.3% for HPR series• standard capacitors on / off times: 25 "÷ 30" (others on request)

QUALITY AND TESTING

Regulations	Capacitors: IEC/EN 60831-1 / 2 certified by IMQ (V1927); Equipment: IEC/EN 61439-1 / 2, IEC/EN 61921.
European directives	Low voltage: 2014/35/CE; Electromagnetic compatibility: 2014/30/CE.
Testing	100% of the automatic equipment is subject to visual inspection, insulation test: phase-phase and phase-earth, battery efficiency and ventilation circuit control: the report is included in the documentation. The capacitors are tested in three consecutive stages of the production process: after winding, regeneration and before labeling.

CONFIGURATION

General notes

- For dimensions, please consult the cabinet drawings, referring to the "Type" column.
- The indication for cable entry (power supply) is as follows: ↑ from the bottom, ✓ side up, ↓ from the top
- The rated power is expressed at 415 V - 50 Hz.

The choice of supply cables depends on the installation conditions, the length of the same and the ambient temperature. For a correct sizing, refer to the IEC 60364-5, CEI 64-8 and the UNEL 35024/01 standards.

Cloud Control System (CCS)



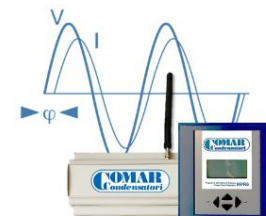







The symbol  indicates that CCS, the remote monitoring system, is pre-installed on the P.F.C. equipment. For any specific information, and to find out the advantages of the Cloud Control System service, refer to the appropriate brochure available on www.comarcond.com or directly on request.



Table

THD(I)max. = 40%

THD(Ic)max. = 90%

Code	Type	Qn (kvar)	Cable entry	In		Banks size				Steps (n)	Switch isolator (A)	Controller (tipo)	CCS	Weight (kg)			
				(A)		(kvar)											
8881412250500	G3E	25	✓	35	6.25	6.25	12.5			4	80	BMR6		15			
8881412310500	G3E	31,25	✓	43	6.25	12.5	12.5			5	80	BMR6		18			
8881412435500	G3E	43,75	✓	61	6.25	12.5	25.0			7	125	BMR6		22			
8881412500500	G3E	50	✓	70	12.5	12.5	25.0			4	125	BMR6		23			
8881412625500	G3E	62,5	✓	87	12.5	25.0	25.0			5	125	BMR6		26			
8881412750500	G4E	75	✓	104	12.5	12.5	25	25		6	160	BMR6		38			
8881413100500	G4E	100	✓	139	12.5	12.5	25	50		8	200	BMR6		46			
8881413125500	G4RM	125	✓	174	12.5	12.5	50	50		5	250	BMR6		83			
8881413150500	G4RM	150	✓	209	25	25	50	50		6	315	BMR6		84			
8881413175500	G4RM	175	✓	243	25	50	50	50		7	400	BMR6		87			
8881413200500	G4RM	200	✓	278	25	25	50	100		8	400	BMR6		89			
8881413225500	G4RM	225	✓	313	25	50	50	100		9	500	BMR6		95			
8881413250500	G4RM	250	✓	348	25	50	75	100		10	500	BMR6		102			
8881413300450	G6E	300	↓	417	25	50	75	75	75	12	630	HPR6		175			
8881413350450	G6E	350	↓	487	50	75	75	75	75	7	800	HPR6		192			
8881413400450	G6E	400	↓	556	50	50	75	75	75	75	8	800	HPR6		207		
8881413450450	G6E	450	↓	626	50	50	50	75	75	150	9	1000	HPR6		240		
8881413500450	G6E	500	↓	696	50	75	75	75	75	150	10	1000	HPR6		255		
8881413600500	G8E	600	↑	836	75	75	75	75	75	75	8	1250	HPR12		330		
8881413650500	G8E	650	↑	904	50	75	75	75	75	75	150	11	1250	HPR12		345	
8881413750500	G8E	750	↑	1045	75	75	75	75	75	150	150	10	1600	HPR12		380	
8881413825500	G8E (II)	825	↑	1149	75	75	75	75	75	150	150	150	11	800+1000	HPR12		510
8881413900500	G8E (II)	900	↑	1254	75	75	75	75	150	150	150	150	12	1000+1000	HPR12		530

Other solutions are available on request.

Discover our range of **MK-AS Capacitors** for **Power Factor Correction** in absolute **Safety!**

Certified by IMQ, our single-phase capacitors are designed to guarantee the best effectiveness in correcting the power factor!



www.comarcond.com

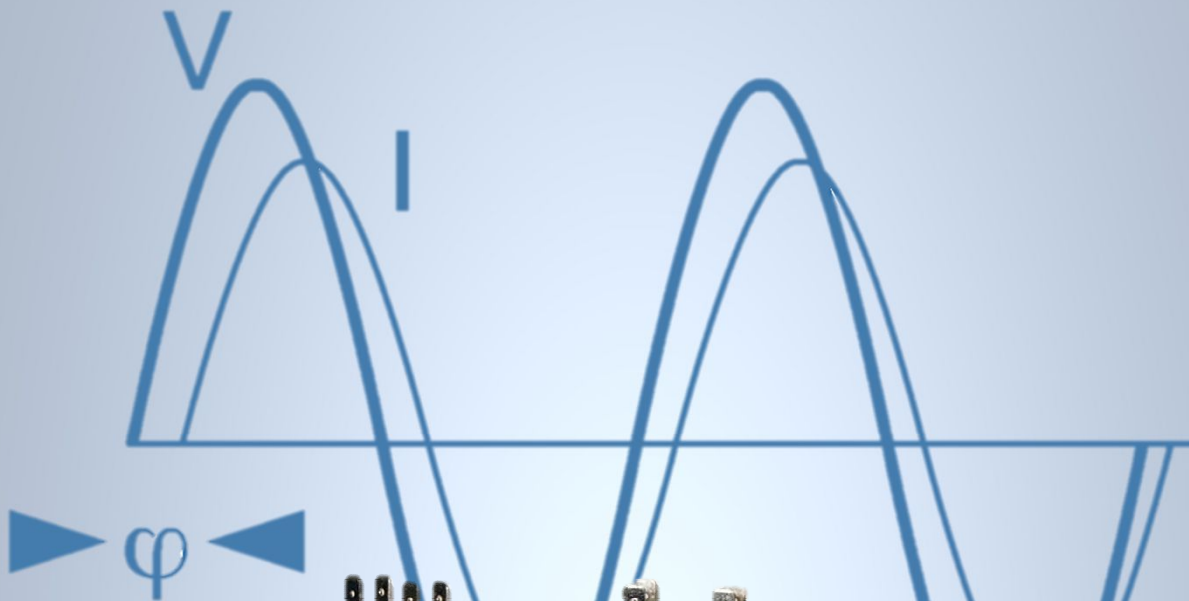

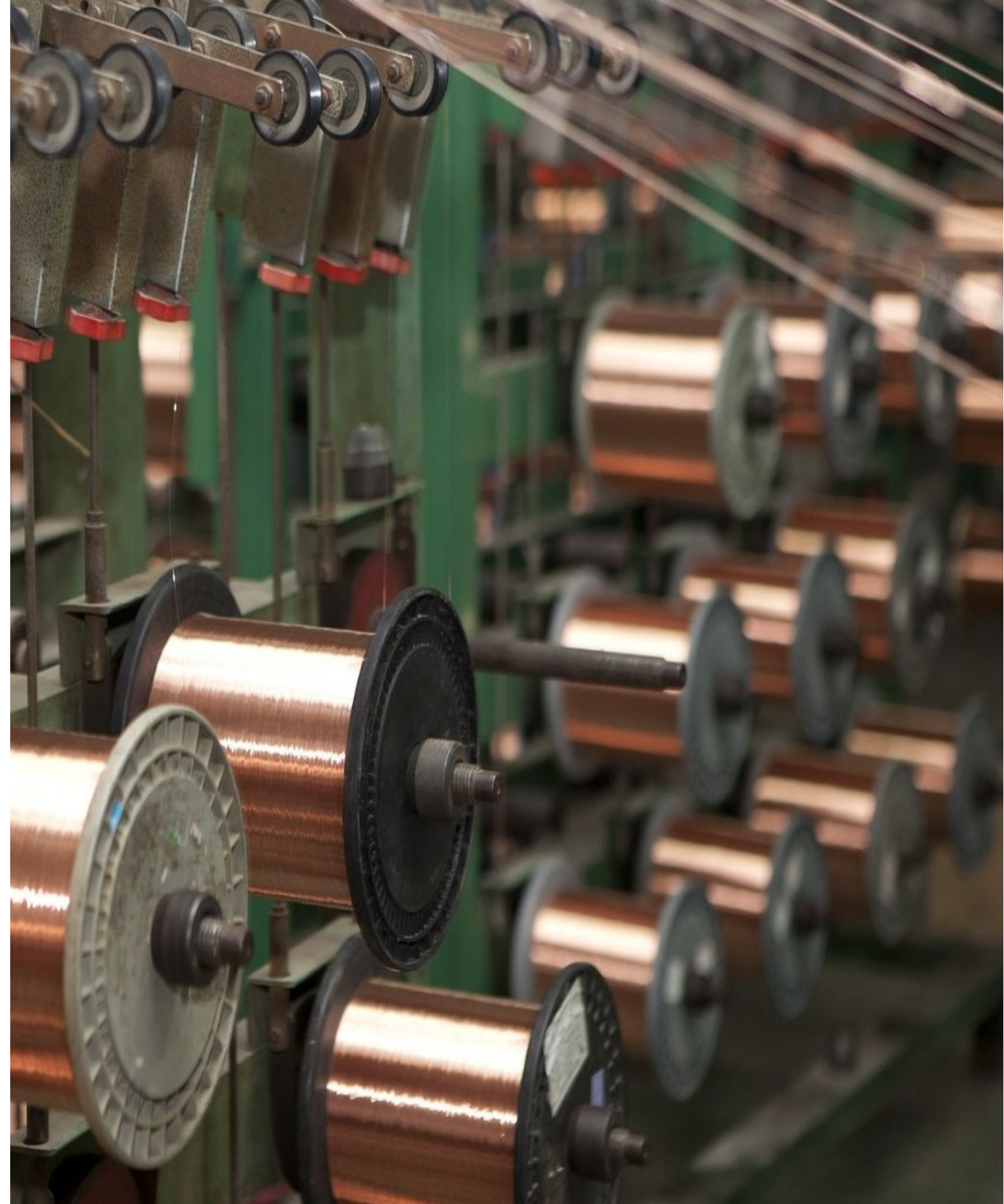

AAR/100 • AAR/138 • AAR/600 • AAR/D20

Automatic P.F.C. with Detuning Reactors



AAR/100

Automatic P.F.C. equipment with Detuning Reactors



AAR/100 series equipment are particularly suitable for three-phase networks with **high harmonic distortion** in current. These equipment guarantee an accurate P.F.C., thanks to a multi-step design that effectively divides the power. In addition, on the G6E and G8E cabinet, all the capacitors banks are assembled on racks, easily removable from the front of the panel, for simple management and maintenance.

PERFORMANCE DATA

■ Rated voltage	400 Vac (others on request)
■ Rated frequency	50 Hz (60 Hz on request)
■ Insulation voltage	690 Vac
■ auxiliary voltage	230 Vac (110 Vac on request)
■ Overvoltage	1,1 Un (rated voltage)
■ Temperature range	-5 / +40 °C
■ Impulse withstand	6 kV (G4E); 8 kV (G4RM, G6E, G8E)

HARMONIC CONTENT

THD(I)max. = 100%	on the network
THD(U)max. = 3%	on the network
$\rho = 7\%$	

TECHNICAL DATA

Enclosures	Made of sheet steel, protected against corrosion by phosphating and epoxy powder coating. RAL 7032 colour (others on request). Degree of protection: external panel IP 31, with the exception of type G4E with IP30 (others on request); internal panel IP 20 at the input of power cables (IP 20 with open doors on request).
Installation	Indoor installation, in a well ventilated position away from heat sources.
Ventilation	Forced.
Switch isolator	Tri-polar under-load type with door lock.
Wiring	The internal connection cables are FS17-450 / 750V type, flame retardant and with very low fumes emission (other types of cables on request). On the non-pre-insulated terminals the connection point is covered with a long-life heat-shrinking sheath. The auxiliary voltage are appropriately identified in compliance with current regulations.
3-pole contactors	Each battery is switched on / off by a three-pole contactor (Class AC6-b) to offer high reliability.
Fuses	Each capacitors bank is protected by fuses. The protection system of both the power circuits (NH-00 curve gG fuses) and the auxiliary ones (isolable fuse holders and 10.3x38 fuses) foresees the use of high breaking power fuses (100kA).
Capacitors	Single-phase capacitors in self-healing metallized polypropylene (MKP), equipped with an anti-burst device and discharge resistance. They are impregnated in vegetable oil, PCB free. Delta connection. Type of continuous service. <ul style="list-style-type: none">• rated voltage: 500 Vac (maximum voltage 550 Vac)• overvoltage: 1.1 x A (8h / 24h)• current overload: 1.3 x In• capacity tolerance: -5% / + 10%• losses due to dissipation: ≤ 0.4 W / kvar• temperature category: -25 / D
Detuning reactors	Tuning frequency: 189 Hz ($\rho = 7\%$) Power losses: 6 W / kvar (AVG) Max. Harmonic distortion of the voltage allowed on the networks is: THDU = 3% (189 Hz). On request: AAR / 6 (THDU = 10%).
Controller	<ul style="list-style-type: none">• type of measurement: varmetric.• amperometric signal: by means of an amperometric transformer with secondary 5A, class 1 - 5VA (by the user)• amperometric signal sensitivity: 2.5% for BMR series, 0.3% for HPR series• standard capacitors on / off times: 25 "÷ 30" (others on request)

QUALITY AND TESTING

Regulations	Capacitors: IEC/EN 60831-1 / 2 certified by IMQ (V1927); Equipment: IEC/EN 61439-1 / 2, IEC/EN 61921.
European directives	Low voltage: 2014/35/CE; Electromagnetic compatibility: 2014/30/CE.

Testing

100% of the automatic equipment is subject to visual inspection, insulation test: phase-phase and phase-earth, battery efficiency and ventilation circuit control: the report is included in the documentation. The capacitors are tested in three consecutive stages of the production process: after winding, regeneration and before labeling.

CONFIGURATION

General notes

- For dimensions, please consult the cabinet drawings, referring to the "Type" column.
- The indication for cable entry (power supply) is as follows: ↑ from the bottom, ✓ side up, ↓ from the top
- The rated power is expressed at 400 V - 50 Hz.

The choice of supply cables depends on the installation conditions, the length of the same and the ambient temperature. For a correct sizing, refer to the IEC 60364-5, CEI 64-8 and the UNEL 35024/01 standards.

Cloud Control System (CCS)

The symbol  indicates that CCS, the remote monitoring system, is pre-installed on the P.F.C. equipment. For any specific information, and to find out the advantages of the Cloud Control System service, refer to the appropriate brochure available on www.comarcond.com or directly on request.

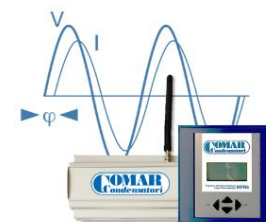





















Table

THD(I)max. = 100%

THD(U)max. = 3%

p = 7%

Code	Type	Qn (kvar)	Cable entry	In		Banks size				Steps (n)	Switch isolator (A)	Controlle r (type)	CCS	Weight (kg)
				(A)		(kvar)								
8561402250700	G4E	25	✓	36	6,25	6,25	12,5			4	160	BMR4		88
8561402310700	G4E	31	✓	44	6,25	12,5	12,5			5	160	BMR4		90
8561402435700	G4E	43,5	✓	63	6,25	12,5	25			7	160	BMR4		100
8561402500700	G4RM	50	↓	72	12,5	12,5	25			4	160	BMR4		105
8561402625700	G4RM	62,5	↓	90	12,5	25	25			5	160	BMR4		115
8561402750700	G4RM	75	↓	108	12,5	12,5	25	25		6	160	BMR4		125
8561403100700	G4RM	100	↓	144	25	25	25	25		4	200	BMR4		145
8561403125700	G6E	125	↓	180	25	50	50			5	315	HPR6		200
8561403150700	G6E	150	↓	216	25	50	75			6	400	HPR6		220
8561403175700	G6E	175	↓	252	25	50	50	50		7	400	HPR6		250
8561403200700	G6E	200	↓	288	25	50	50	75		8	500	HPR6		270
8561403225700	G6E	225	↓	324	25	50	75	75		9	500	HPR6		300
8561403250700	G6E	250	↓	360	25	25	50	75	75	10	630	HPR6		320
8561403275700	G6E	275	↓	397	25	50	50	75	75	11	630	HPR6		340
8561403300700	G6E	300	↓	432	25	50	75	75	75	12	800	HPR6		360
8561403350700	G8E	350	↑	504	50	75	75	75	75	9	800	HPR6		390
8561403375700	G8E	375	↑	541	25	50	75	75	75	15	800	HPR6		410
8561403400700	G8E (III)	400	↑	576	50	50	75	75	75	14	1000	HPR6		550
8561403450700	G8E (III)	450	↑	648	25	50	75	75	75	18	1000	HPR12		600
8561403500700	G8E (III)	500	↑	720	50	75	75	75	75	13	1250	HPR12		650
8561403550700	G8E (III)	550	↑	792	50	50	75	75	75	19	1250	HPR12		700
8561403600700	G8E (III)	600	↑	864	75	75	75	75	75	8	1250	HPR12		750
8561403650700	G8E (III)	650	↑	936	50	75	75	75	75	16	800+630	HPR12		800
8561403750700	G8E (III)	750	↑	1080	75	75	75	75	150	10	800+800	HPR12		850
8561403825700	G8E (III)	825	↑	1191	75	75	75	75	150	11	800+1000	HPR12		1000
8561403900700	G8E (III)	900	↑	1299	75	75	75	75	150	12	800+1250	HPR12		1050
8561403975700	G8E (III)	975	↑	1407	75	75	75	150	150	13	800+1250	HPR12		1100
8561404105700	G8E (III)	1050	↑	1516	75	75	150	150	150	14	800+1600	HPR12		1150

Other solutions are available on request.

AAR/138

Automatic P.F.C. equipment with Detuning Reactors



AAR/138 series equipment are particularly suitable for three-phase networks with **high harmonic distortion** in current with presence of **3° grade harmonics**. These equipment guarantee an accurate P.F.C., thanks to a multi-step design that effectively divides the power. In addition, on the G6E and G9E cabinet, all the capacitors banks are assembled on racks, easily removable from the front of the panel, for simple management and maintenance.

PERFORMANCE DATA

■ Rated voltage	400 Vac (others on request)
■ Rated frequency	50 Hz (60 Hz on request)
■ Insulation voltage	690 Vac
■ auxiliary voltage	230 Vac (110 Vac on request)
■ Overvoltage	1,1 Un (rated voltage)
■ Temperature range	-5 / +40 °C
■ Impulse withstand	8 kV

HARMONIC CONTENT

THD(I)max. = 100%	on the network
THD(U)max. = 6%	on the network
$\rho = 14\%$	

TECHNICAL DATA

Enclosures	Made of sheet steel, protected against corrosion by phosphating and epoxy powder coating. RAL 7032 colour (others on request). Degree of protection: external panel IP 31(others on request); internal panel IP 20 at the input of power cables (IP 20 with open doors on request).
Installation	Indoor installation, in a well ventilated position away from heat sources.
Ventilation	Forced.
Switch isolator	Tri-polar under-load type with door lock.
Wiring	The internal connection cables are FS17-450 / 750V type, flame retardant and with very low fumes emission (other types of cables on request). On the non-pre-insulated terminals the connection point is covered with a long-life heat-shrinking sheath. The auxiliary voltage are appropriately identified in compliance with current regulations.
3-pole contactors	Each battery is switched on / off by a three-pole contactor (Class AC6-b) to offer high reliability.
Fuses	Each capacitors bank is protected by fuses. The protection system of both the power circuits (NH-00 curve gG fuses) and the auxiliary ones (isolable fuse holders and 10.3x38 fuses) foresees the use of high breaking power fuses (100kA).
Capacitors	Single-phase capacitors in self-healing metallized polypropylene (MKP), equipped with an anti-burst device and discharge resistance. They are impregnated in vegetable oil, PCB free. Delta connection. Type of continuous service. <ul style="list-style-type: none">• rated voltage: 500 Vac (maximum voltage 550 Vac)• overvoltage: 1.1 x A (8h / 24h)• current overload: 1.3 x In• capacity tolerance: -5% / + 10%• losses due to dissipation: ≤ 0.4 W / kvar• temperature category: -25 / D
Detuning reactors	Tuning frequency: 138 Hz ($\rho = 14\%$) Power losses: 6,5 W / kvar (AVG) Max. Harmonic distortion of the voltage allowed on the networks is: THDU = 6% (138 Hz). On request: higher THDU values.
Controller	<ul style="list-style-type: none">• type of measurement: varmetric.• amperometric signal: by means of an amperometric transformer with secondary 5A, class 1 - 5VA (by the user)• amperometric signal sensitivity: 2.5% for BMR series, 0.3% for HPR series• standard capacitors on / off times: 25 "÷ 30" (others on request)

QUALITY AND TESTING

Regulations	Capacitors: IEC/EN 60831-1 / 2 certified by IMQ (V1927); Equipment: IEC/EN 61439-1 / 2, IEC/EN 61921.
European directives	Low voltage: 2014/35/CE; Electromagnetic compatibility: 2014/30/CE.

Testing

100% of the automatic equipment is subject to visual inspection, insulation test: phase-phase and phase-earth, battery efficiency and ventilation circuit control: the report is included in the documentation. The capacitors are tested in three consecutive stages of the production process: after winding, regeneration and before labeling.

CONFIGURATION

General notes

- For dimensions, please consult the cabinet drawings, referring to the "Type" column.
- The indication for cable entry (power supply) is as follows: ↑ from the bottom, ✓ side up, ↓ from the top
- The rated power is expressed at 400 V - 50 Hz.

The choice of supply cables depends on the installation conditions, the length of the same and the ambient temperature. For a correct sizing, refer to the IEC 60364-5, CEI 64-8 and the UNEL 35024/01 standards.

Cloud Control System (CCS)

The symbol  indicates that CCS, the remote monitoring system, is pre-installed on the P.F.C. equipment. For any specific information, and to find out the advantages of the Cloud Control System service, refer to the appropriate brochure available on www.comarcond.com or directly on request.

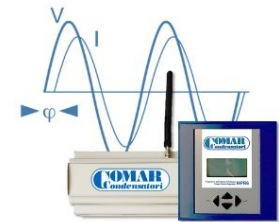























Table

THD(I)max. = 100%

THD(U)max. = 4%

p = 14%

Code	Type	Qn (kvar)	Cable entry	In (A)	Banks size (kvar)				Steps (n)	Switch isolator (A)	Controller (type)	CCS	Weight (kg)
8821402500700	G4RM	50	↓	72	12.5	12.5	25		4	200	BMR6		105
8821402625750	G4RM	62.5	↓	90	12.5	25	25		5	200	BMR6		115
8821402750700	G4RM	75	↓	108	12.5	12.5	25	25	6	200	BMR6		125
8821403100750	G6E	100	↓	144	25	25	50		4	200	HPR6		190
8821403125700	G6E	125	↓	180	25	50	50		5	315	HPR6		200
8821403150750	G6E	150	↓	216	25	25	50	50	6	400	HPR6		220
8821403175700	G6E	175	↓	252	25	50	50	50	7	400	HPR6		250
8821403200750	G9E	200	↑	288	25	50	50	75	8	500	HPR6		290
8821403225750	G9E	225	↑	324	25	50	75	75	9	500	HPR6		320
8821403250750	G9E	250	↑	360	25	25	50	75	10	630	HPR6		340
8821403275750	G9E	275	↑	397	25	50	50	75	11	630	HPR6		370
8821403300750	G9E	300	↑	432	25	50	75	75	12	800	HPR6		380
8821403350750	G9E	350	↑	504	50	75	75	75	13	800	HPR6		410
8821403375750	G9E	375	↑	541	25	50	75	75	14	800	HPR6		430
8821403400750	G9E (II)	400	↑	576	50	50	75	75	15	1000	HPR6		590
8821403450750	G9E (II)	450	↑	648	25	50	75	75	16	1000	HPR12		640
8821403500750	G9E (II)	500	↑	720	50	75	75	75	17	1250	HPR12		690
8821403550750	G9E (II)	550	↑	792	50	50	75	75	18	1250	HPR12		740
8821403600750	G9E (II)	600	↑	864	75	75	75	75	19	1250	HPR12		790
8821403650750	G9E (II)	650	↑	936	50	75	75	75	20	800+630	HPR12		840
8821403750750	G9E (II)	750	↑	1080	75	75	75	75	21	800+800	HPR12		890
8821403825750	G9E (III)	825	↑	1191	75	75	75	75	22	800+1000	HPR12		1060
8821403900750	G9E (III)	900	↑	1299	75	75	75	75	23	800+1250	HPR12		1110
8821403975750	G9E (III)	975	↑	1407	75	75	75	150	24	800+1250	HPR12		1160
8821404105750	G9E (III)	1050	↑	1516	75	75	150	150	25	800+1600	HPR12		1210

Other solutions are available on request.

AAR/600

Automatic P.F.C. equipment with Detuning Reactors



AAR/600 series equipment are particularly suitable for three-phase networks with **high harmonic distortion** in current. These equipment guarantee an accurate P.F.C., thanks to a multi-step design that effectively divides the power. In addition, on the G6E and G8E cabinet, all the capacitors banks are assembled on racks, easily removable from the front of the panel, for simple management and maintenance.

PERFORMANCE DATA

■ Rated voltage	400 Vac (others on request)
■ Rated frequency	50 Hz (60 Hz on request)
■ Insulation voltage	690 Vac
■ auxiliary voltage	230 Vac (110 Vac on request)
■ Overvoltage	1,1 Un (rated voltage)
■ Temperature range	-5 / +40 °C
■ Impulse withstand	8 kV

HARMONIC CONTENT

THD(I)max. = 100%	on the network
THD(U)max. = 6%	on the network
$\rho = 7\%$	

TECHNICAL DATA

Enclosures	Made of sheet steel, protected against corrosion by phosphating and epoxy powder coating. RAL 7032 colour (others on request). Degree of protection: external panel IP 31 (others on request); internal panel IP 20 at the input of power cables (IP 20 with open doors on request).
Installation	Indoor installation, in a well ventilated position away from heat sources.
Ventilation	Forced.
Switch isolator	Tri-polar under-load type with door lock.
Wiring	The internal connection cables are FS17-450 / 750V type, flame retardant and with very low fumes emission (other types of cables on request). On the non-pre-insulated terminals the connection point is covered with a long-life heat-shrinking sheath. The auxiliary voltage are appropriately identified in compliance with current regulations.
3-pole contactors	Each battery is switched on / off by a three-pole contactor (Class AC6-b) to offer high reliability.
Fuses	Each capacitors bank is protected by fuses. The protection system of both the power circuits (NH-00 curve gG fuses) and the auxiliary ones (isolable fuse holders and 10.3x38 fuses) foresees the use of high breaking power fuses (100kA).
Capacitors	Single-phase capacitors in self-healing metallized polypropylene (MKP), equipped with an anti-burst device and discharge resistance. They are impregnated in vegetable oil, PCB free. Delta connection. Type of continuous service. <ul style="list-style-type: none">• rated voltage: 500 Vac (maximum voltage 550 Vac)• overvoltage: 1.1 x A (8h / 24h)• current overload: 1.3 x In• capacity tolerance: -5% / + 10%• losses due to dissipation: ≤ 0.4 W / kvar• temperature category: -25 / D
Detuning reactors	Tuning frequency: 189 Hz ($\rho = 7\%$) Power losses: 6 W / kvar (AVG) Max. Harmonic distortion of the voltage allowed on the networks is: THDU = 6% (189 Hz).
Controller	<ul style="list-style-type: none">• type of measurement: varmetric.• amperometric signal: by means of an amperometric transformer with secondary 5A, class 1 - 5VA (by the user)• amperometric signal sensitivity: 2.5% for BMR series, 0.3% for HPR series• standard capacitors on / off times: 25 "÷ 30" (others on request)

QUALITY AND TESTING

Regulations	Capacitors: IEC/EN 60831-1 / 2 certified by IMQ (V1927); Equipment: IEC/EN 61439-1 / 2, IEC/EN 61921.
European directives	Low voltage: 2014/35/CE; Electromagnetic compatibility: 2014/30/CE.

Testing

100% of the automatic equipment is subject to visual inspection, insulation test: phase-phase and phase-earth, battery efficiency and ventilation circuit control: the report is included in the documentation. The capacitors are tested in three consecutive stages of the production process: after winding, regeneration and before labeling.

CONFIGURATION

General notes

- For dimensions, please consult the cabinet drawings, referring to the "Type" column.
- The indication for cable entry (power supply) is as follows: ↑ from the bottom, ✓ side up, ↓ from the top
- The rated power is expressed at 400 V - 50 Hz.

The choice of supply cables depends on the installation conditions, the length of the same and the ambient temperature. For a correct sizing, refer to the IEC 60364-5, CEI 64-8 and the UNEL 35024/01 standards.

Cloud Control System (CCS)

The symbol  indicates that CCS, the remote monitoring system, is pre-installed on the P.F.C. equipment. For any specific information, and to find out the advantages of the Cloud Control System service, refer to the appropriate brochure available on www.comarcond.com or directly on request.

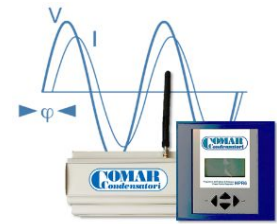























Table

THD(I)max. = 100%

THD(U)max. = 6%

p = 7%

Code	Type	Qn (kvar)	Cable entry	In (A)	Banks size (kvar)						Steps (n)	Switch isolator (A)	Controller (type)	CCS	Weight (kg)
8551403100600	G6E	100	↓	144	25	25	50				4	200	HPR6		180
8551403125600	G6E	125	↓	180	25	50	50				5	315	HPR6		210
8551403150600	G6E	150	↓	216	25	50	75				6	400	HPR6		230
8551403175600	G6E	175	↓	252	25	50	50	50			7	400	HPR6		260
8551403200600	G6E	200	↓	288	25	50	50	75			8	500	HPR6		280
8551403225600	G6E	225	↓	324	25	50	75	75			9	500	HPR6		315
8551403250600	G6E	250	↓	360	25	25	50	75	75		10	630	HPR6		355
8551403275600	G8E	275	↑	397	25	50	50	75	75		11	630	HPR6		370
8551403300600	G8E	300	↑	432	25	50	75	75	75		12	800	HPR6		380
8551403350600	G8E	350	↑	504	50	75	75	75	75		9	800	HPR6		400
8551403375600	G8E (II)	375	↑	541	25	50	75	75	75	75	15	800	HPR6		520
8551403400600	G8E (II)	400	↑	576	50	50	75	75	75	75	14	1000	HPR6		570
8551403450600	G8E (II)	450	↑	648	25	50	75	75	75	75	18	1000	HPR12		620
8551403500600	G8E (II)	500	↑	720	50	75	75	75	75	75	13	1250	HPR12		670
8551403550600	G8E (II)	550	↑	792	50	50	75	75	75	75	19	1250	HPR12		720
8551403600600	G8E (II)	600	↑	864	75	75	75	75	75	75	8	1250	HPR12		770
8551403650600	G8E (II)	650	↑	936	50	75	75	75	75	75	150	800+630	HPR12		820
8551403750600	G8E (II)	750	↑	1080	75	75	75	75	75	150	150	800+800	HPR12		880
8551403825600	G8E (III)	825	↑	1191	75	75	75	75	150	150	150	800+1000	HPR12		1040
8551403900600	G8E (III)	900	↑	1299	75	75	75	75	150	150	150	800+1250	HPR12		1090
8551403975600	G8E (III)	975	↑	1407	75	75	75	150	150	150	150	800+1250	HPR12		1140
8551404100600	G8E (III)	1050	↑	1516	75	75	150	150	150	150	150	800+1600	HPR12		1190

Other solutions are available on request.

AAR/D20

Automatic P.F.C. equipment with Detuning Reactors



AAR/D20 series equipment are particularly suitable for three-phase networks with **high harmonic distortion** in current. These equipment guarantee an accurate P.F.C., thanks to a multi-step design that effectively divides the power. In addition, on the G6E and G9E cabinet, all the capacitors banks are assembled on racks, easily removable from the front of the panel, for simple management and maintenance.

PERFORMANCE DATA

■ Rated voltage	400 Vac (others on request)
■ Rated frequency	50 Hz (60 Hz on request)
■ Insulation voltage	690 Vac
■ Auxiliary voltage	230 Vac (110 Vac on request)
■ Overvoltage	1,1 Un (rated voltage)
■ Temperature range	-5 / +40 °C
■ Impulse withstand	8 kV

HARMONIC CONTENT

THD(I)max. = 100%	on the network
THD(U)max. = 20%	on the network
$\rho = 7\%$	

TECHNICAL DATA

Enclosures	Made of sheet steel, protected against corrosion by phosphating and epoxy powder coating. RAL 7032 colour (others on request). Degree of protection: external panel IP 31 (others on request); internal panel IP 20 at the input of power cables (IP 20 with open doors on request).
Installation	Indoor installation, in a well ventilated position away from heat sources.
Ventilation	Forced.
Switch isolator	Tri-polar under-load type with door lock.
Wiring	The internal connection cables are FS17-450 / 750V type, flame retardant and with very low fumes emission (other types of cables on request). On the non-pre-insulated terminals the connection point is covered with a long-life heat-shrinking sheath. The auxiliary voltage are appropriately identified in compliance with current regulations.
3-pole contactors	Each battery is switched on / off by a three-pole contactor (Class AC6-b) to offer high reliability.
Fuses	Each capacitors bank is protected by fuses. The protection system of both the power circuits (NH-00 curve gG fuses) and the auxiliary ones (isolable fuse holders and 10.3x38 fuses) foresees the use of high breaking power fuses (100kA).
Capacitors	Single-phase capacitors in self-healing metallized polypropylene (MKP), equipped with an anti-burst device and discharge resistance. They are impregnated in vegetable oil, PCB free. Delta connection. Type of continuous service. <ul style="list-style-type: none">• rated voltage: 550 Vac (maximum voltage 600 Vac)• overvoltage: 1.1 x A (8h / 24h)• current overload: 1.3 x In• capacity tolerance: -5% / + 10%• losses due to dissipation: ≤ 0.4 W / kvar• temperature category: -25 / D
Detuning reactors	Tuning frequency: 189 Hz ($\rho = 7\%$) Power losses: 6 W / kvar (AVG) Max. Harmonic distortion of the voltage allowed on the networks is: THDU = 20% (189 Hz).
Controller	<ul style="list-style-type: none">• type of measurement: varmetric.• amperometric signal: by means of an amperometric transformer with secondary 5A, class 1 - 5VA (by the user)• amperometric signal sensitivity: 2.5% for BMR series, 0.3% for HPR series• standard capacitors on / off times: 25 "± 30" (others on request)

QUALITY AND TESTING

Regulations	Capacitors: IEC/EN 60831-1 / 2 certified by IMQ (V1927); Equipment: IEC/EN 61439-1 / 2, IEC/EN 61921.
European directives	Low voltage: 2014/35/CE; Electromagnetic compatibility: 2014/30/CE.

Testing

100% of the automatic equipment is subject to visual inspection, insulation test: phase-phase and phase-earth, battery efficiency and ventilation circuit control: the report is included in the documentation. The capacitors are tested in three consecutive stages of the production process: after winding, regeneration and before labeling.

CONFIGURATION

General notes

- For dimensions, please consult the cabinet drawings, referring to the "Type" column.
- The indication for cable entry (power supply) is as follows: ↑ from the bottom, ↙ side up, ↓ from the top
- The rated power is expressed at 400 V - 50 Hz.

The choice of supply cables depends on the installation conditions, the length of the same and the ambient temperature. For a correct sizing, refer to the IEC 60364-5, CEI 64-8 and the UNEL 35024/01 standards.

Cloud Control System (CCS)

The symbol  indicates that CCS, the remote monitoring system, is pre-installed on the P.F.C. equipment. For any specific information, and to find out the advantages of the Cloud Control System service, refer to the appropriate brochure available on www.comarcond.com or directly on request.

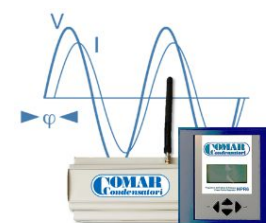























Table

THD(I)max. = 100%

THD(U)max. = 20%

$\rho = 7\%$

Code	Type	Qn (kvar)	Cable entry	In (A)	Banks size (kvar)				Steps (n)	Switch isolator (A)	Controller (type)	CCS	Weight (kg)			
8541403100620	G6E	100	↓	144	25	25	50		4	200	HPR6		200			
8541403125620	G6E	125	↓	180	25	50	50		5	315	HPR6		259			
8541403150720	G6E	150	↓	216	25	25	50	50	6	400	HPR6		276			
8541403175620	G6E	175	↓	252	25	50	50	50	7	400	HPR6		332			
8541403200720	G9E	200	↑	288	25	50	50	75	8	500	HPR6		349			
8541403225720	G9E	225	↑	324	25	50	75	75	9	500	HPR6		376			
8541403250720	G9E	250	↑	360	25	25	50	75	75	10	630	HPR6		400		
8541403275720	G9E	275	↑	397	25	50	50	75	75	11	630	HPR6		440		
8541403300720	G9E	300	↑	432	25	50	75	75	75	12	800	HPR6		485		
8541403350720	G9E	350	↑	504	50	75	75	75	75	7	800	HPR6		520		
8541403375720	G9E	375	↑	541	75	75	75	75	75	5	800	HPR6		540		
8541403400620	G9E (II)	400	↑	576	50	50	75	75	75	75	8	1000	HPR6		656	
8541403450620	G9E (II)	450	↑	648	25	50	75	75	75	75	75	18	1000	HPR12		772
8541403500620	G9E (II)	500	↑	720	50	75	75	75	75	75	75	10	1250	HPR12		800
8541403550620	G9E (II)	550	↑	792	50	50	75	75	75	75	75	11	1250	HPR12		866
8541403600620	G9E (II)	600	↑	864	75	75	75	75	75	75	75	8	1250	HPR12		910
8541403650620	G9E (II)	650	↑	936	50	75	75	75	75	75	150	13	800+630	HPR12		985
8541403750620	G9E (II)	750	↑	1080	75	75	75	75	75	75	150	10	800+800	HPR12		1050
8541403825620	G9E (III)	825	↑	1191	75	75	75	75	75	150	150	11	800+1000	HPR12		1220
8541403900620	G9E (III)	900	↑	1299	75	75	75	75	150	150	150	12	800+1250	HPR12		1300
8541403975620	G9E (III)	975	↑	1407	75	75	75	150	150	150	150	13	800+1250	HPR12		1380
8541404105620	G9E (III)	1050	↑	1516	75	75	150	150	150	150	150	14	800+1600	HPR12		1460

Other solutions are available on request.



Try the **Cloud Control System!**

The solution for the remote monitoring of the Automatic P.F.C. Equipment

www.comarcond.com

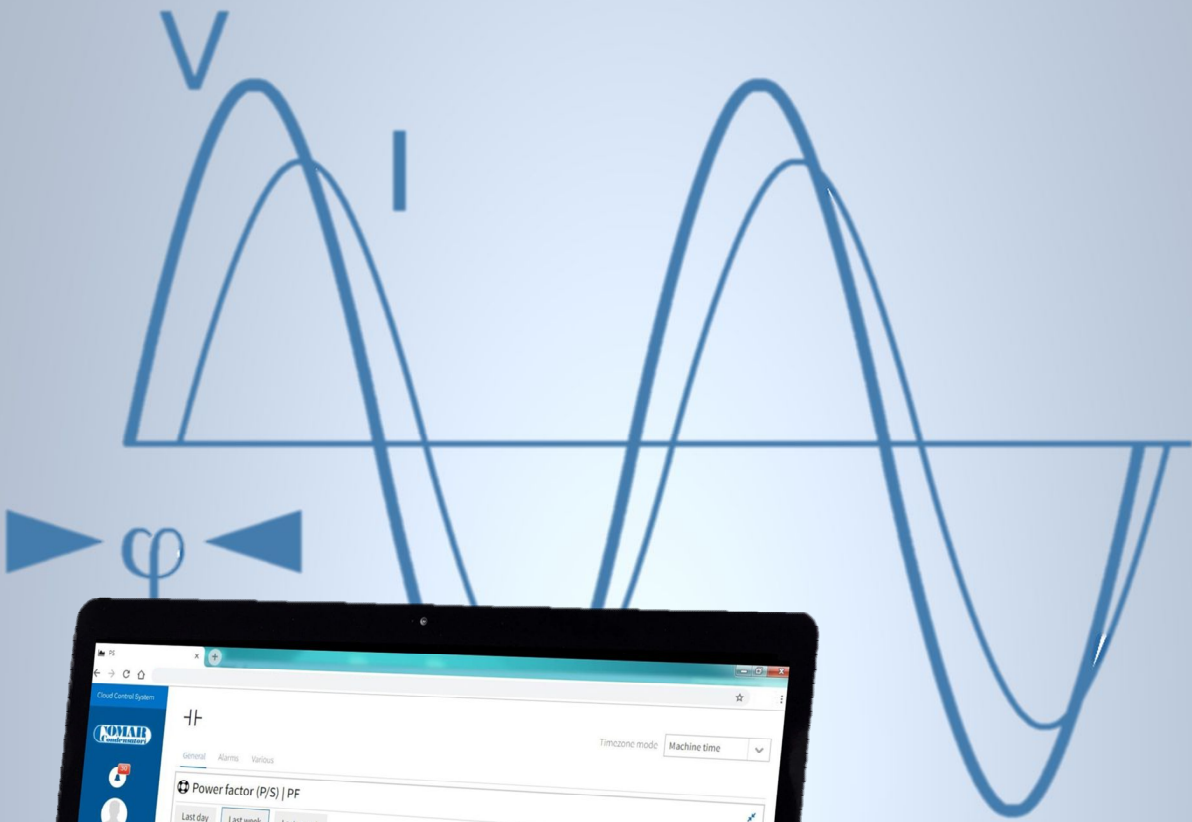

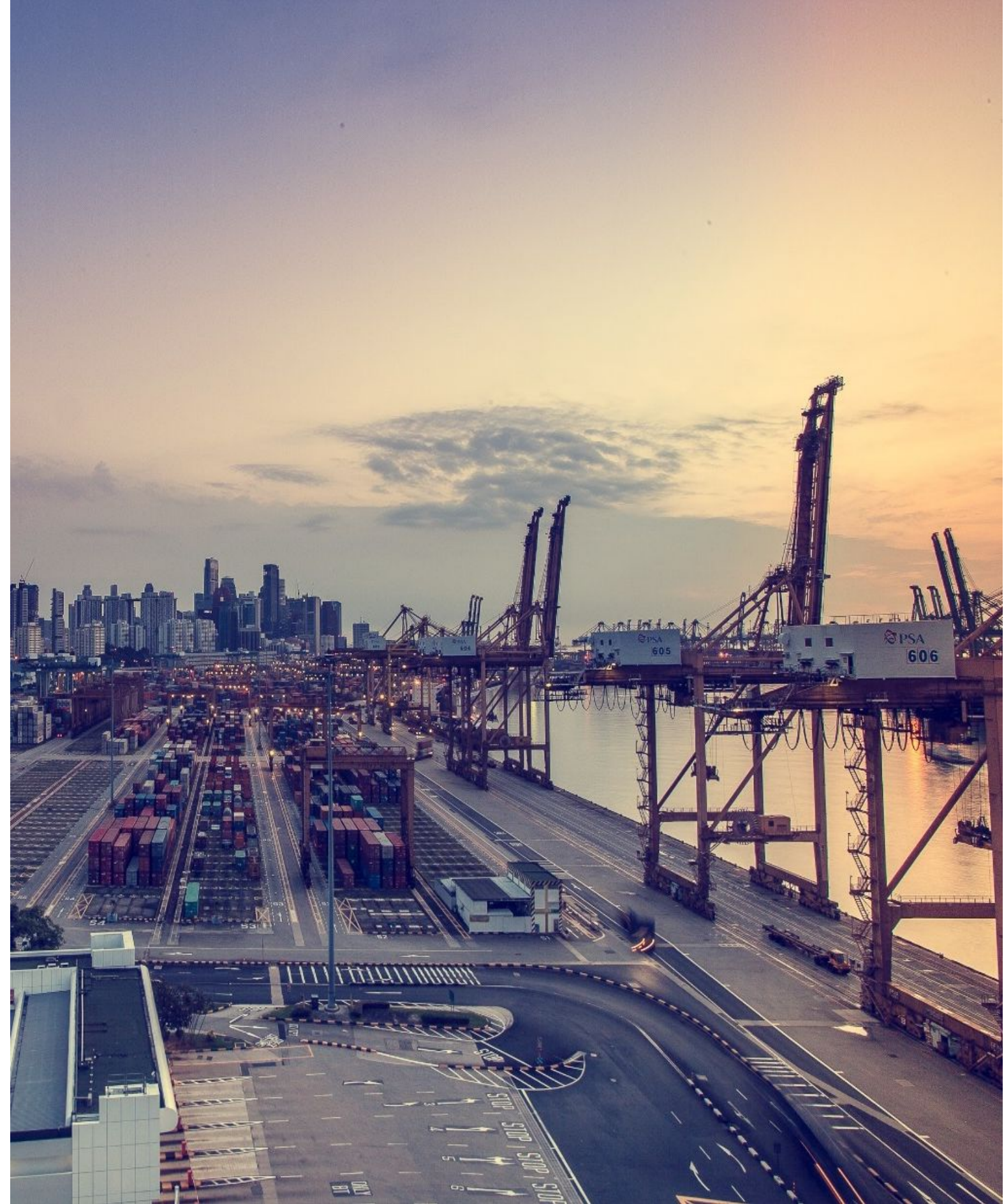

B35-ST • AAR/100-ST

Automatic P.F.C. with Static Insertion



B35-ST

Automatic P.F.C. equipment with Static Insertion



The entire **B35-ST** series is equipped with "zero-crossing" static relays (thyristors), and it has been designed to improve the performance of traditional equipment, such as: increasing the life of the capacitors banks, decreasing the time response of the equipment to follow rapid changes in loads with a **medium-low harmonic distortion**.

PERFORMANCE DATA

■ Rated voltage	415 Vac (others on request)
■ Rated frequency	50 Hz (60 Hz on request)
■ Insulation voltage	690 Vac
■ auxiliary voltage	230 Vac (110 Vac on request)
■ Overvoltage	1,1 Un (rated voltage)
■ Temperature range	-5 / +40 °C
■ Impulse withstand	8 kV

HARMONIC CONTENT (in the absence of resonance)

THD(I)max. = 25%	on the network
THD(Ic)max. = 70%	on the capacitors

TECHNICAL DATA

Enclosures	Made of sheet steel, protected against corrosion by phosphating and epoxy powder coating. RAL 7032 colour (others on request). Degree of protection: external panel IP 31 (others on request); internal panel IP 20 at the input of power cables (IP 20 with open doors on request).
Installation	Indoor installation, in a well ventilated position away from heat sources.
Ventilation	Forced.
Switch isolator	Tri-polar under-load type with door lock.
Wiring	The internal connection cables are FS17-450 / 750V type, flame retardant and with very low fumes emission (other types of cables on request). On the non-pre-insulated terminals the connection point is covered with a long-life heat-shrinking sheath. The auxiliary voltage are appropriately identified in compliance with current regulations.
Insertion	Static, based on the use of thyristors, controlled by a microprocessor such that the switching on of the electronic components occurs when the potential difference between the network and the capacitors is zero. In this way dangerous transients are avoided, with negative effects on the network, even when the capacitors are partially charged. The disconnection takes place at zero current (that is, shutdown occurs at the natural zero current passage of the static power factor correction) The microprocessor control ensures for the static system a maximum delay for the insertion of the capacitor banks of 200 ms.
Fuses	Each capacitors bank is protected by fuses. The protection system of both the power circuits (NH-00 curve gG fuses) and the auxiliary ones (isolable fuse holders and 10.3x38 fuses) foresees the use of high breaking power fuses (100kA).
Capacitors	Single-phase capacitors in self-healing metallized polypropylene (MKP), equipped with an anti-burst device and discharge resistance. They are impregnated in vegetable oil, PCB free. Delta connection. Type of continuous service. <ul style="list-style-type: none">• rated voltage: 440 Vac (maximum voltage 500 Vac)• overvoltage: 1.1 x A (8h / 24h)• current overload: 1.3 x In• capacity tolerance: -5% / + 10%• losses due to dissipation: ≤0.4 W / kvar• temperature category: -25 / D
Controller	<ul style="list-style-type: none">• type of measurement: varmetric.• amperometric signal: by means of an amperometric transformer with secondary 5A, class 1 - 5VA (by the user)• amperometric signal sensitivity: 2.5% for BMR series, 0.3% for HPR series• switching on / off times of the single capacitor bank: 1 "

QUALITY AND TESTING

- Regulations** Capacitors: IEC/EN 60831-1 / 2 certified by IMQ (V1927); Equipment: IEC/EN 61439-1 / 2, IEC/EN 61921.
- European directives** Low voltage: 2014/35/CE; Electromagnetic compatibility: 2014/30/CE.
- Testing** 100% of the automatic equipment is subject to visual inspection, insulation test: phase-phase and phase-earth, battery efficiency and ventilation circuit control: the report is included in the documentation. The capacitors are tested in three consecutive stages of the production process: after winding, regeneration and before labeling.

CONFIGURATION

General notes

- For dimensions, please consult the cabinet drawings, referring to the "Type" column.
- The indication for cable entry (power supply) is as follows: ↑ from the bottom, ↙ side up, ↓ from the top
- The rated power is expressed at 415 V - 50 Hz.

The choice of supply cables depends on the installation conditions, the length of the same and the ambient temperature. For a correct sizing, refer to the IEC 60364-5, CEI 64-8 and the UNEL 35024/01 standards.

Cloud Control System (CCS)



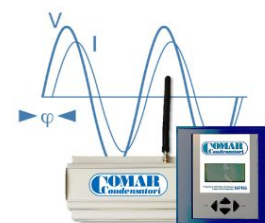











The symbol  indicates that CCS, the remote monitoring system, is pre-installed on the P.F.C. equipment. For any specific information, and to find out the advantages of the Cloud Control System service, refer to the appropriate brochure available on www.comarcond.com or directly on request.



Table

THD(I)max. = 25%

THD(Ic)max. = 70%

Code	Type	Qn (kvar)	Cable entry	In (A)	Banks size (kvar)							Steps (n)	Switch isolator (A)	Controller (type)	CCS	Weight (kg)
8531413175300	G6E	175	↓	243	25	50	50	50				7	400	HPR6		165
8531413200300	G6E	200	↓	278	25	25	50	100				8	400	HPR6		180
8531413225300	G6E	225	↓	313	25	50	50	100				9	500	HPR6		200
8531413250300	G6E	250	↓	348	25	50	75	100				10	500	HPR6		220
8531413300300	G6E	300	↓	417	25	50	75	75	75			6	630	HPR6		270
8531413350300	G6E	350	↓	487	50	75	75	75	75			7	800	HPR6		280
8531413400300	G6E	400	↓	556	50	50	75	75	75	75		8	800	HPR6		290
8531413450300	G8E	450	↑	626	50	50	50	75	75	150		9	1000	HPR6		300
8531413500300	G8E	500	↑	696	50	75	75	75	75	150		10	1000	HPR6		310
8531413600300	G8E (II)	600	↑	836	75	75	75	75	75	75	75	22	1250	HPR12		480
8531413700300	G8E (III)	750	↑	1045	75	75	75	75	75	150	150	14	1600	HPR12		510
8531413800300	G8E (III)	825	↑	1149	75	75	75	75	75	150	150	16	800+1000	HPR12		550
8531413900300	G8E (III)	900	↑	1254	75	75	75	75	150	150	150	18	1000+1000	HPR12		580
8531414100300	G8E (III)	1050	↑	1462	75	75	150	150	150	150	150	20	1000+1000	HPR12		610

All automatic P.F.C. series, with or without blocking reactors, can be realized with static insertion. Other solutions are available on request

AAR/100-ST

Automatic P.F.C. equipment with Static Insertion



The entire **AAR/100-ST** series is equipped with "zero-crossing" static relays (thyristors), and it has been designed to improve the performance of traditional equipment, such as: increasing the life of the capacitors banks, decreasing the time response of the equipment to follow rapid changes in loads. Suitable for applications with **high harmonic distortion** such as automotive, harbours, mechanical workshops, ...

PERFORMANCE DATA

■ Rated voltage	400 Vac (others on request)
■ Rated frequency	50 Hz (60 Hz on request)
■ Insulation voltage	690 Vac
■ auxiliary voltage	230 Vac (110 Vac on request)
■ Overvoltage	1,1 Un (rated voltage)
■ Temperature range	-5 / +40 °C
■ Impulse withstand	8 kV

HARMONIC CONTENT

THD(I)max. = 100%	on the network
THD(U)max. = 3%	on the network
$\rho = 7\%$	

TECHNICAL DATA

Enclosures	Made of sheet steel, protected against corrosion by phosphating and epoxy powder coating. RAL 7032 colour (others on request). Degree of protection: external panel IP 31 (others on request); internal panel IP 20 at the input of power cables (IP 20 with open doors on request).
Installation	Indoor installation, in a well ventilated position away from heat sources.
Ventilation	Forced.
Switch isolator	Tri-polar under-load type with door lock.
Wiring	The internal connection cables are FS17-450 / 750V type, flame retardant and with very low fumes emission (other types of cables on request). On the non-pre-insulated terminals the connection point is covered with a long-life heat-shrinking sheath. The auxiliary voltage are appropriately identified in compliance with current regulations.
Insertion	Static, based on the use of thyristors, controlled by a microprocessor such that the switching on of the electronic components occurs when the potential difference between the network and the capacitors is zero. In this way dangerous transients are avoided, with negative effects on the network, even when the capacitors are partially charged. The disconnection takes place at zero current (that is, shutdown occurs at the natural zero current passage of the static power factor correction) The microprocessor control ensures for the static system a maximum delay for the insertion of the capacitor banks of 200 ms.
Fuses	Each capacitors bank is protected by fuses. The protection system of both the power circuits (NH-00 curve gG fuses) and the auxiliary ones (isolable fuse holders and 10.3x38 fuses) foresees the use of high breaking power fuses (100kA).
Capacitors	Condensatori monofase in polipropilene metallizzato autorigenerabile (MKP), dotati di dispositivo antiscoppio e resistenza di scarica. Sono impregnati in olio vegetale, esente da PCB. Collegamento a triangolo. Tipo di servizio continuativo. <ul style="list-style-type: none">• tensione nominale: 500 Vac (tensione massima 550 Vac)• sovratensione: 1,1 x Un (8h / 24h)• sovraccarico di corrente: 1,3 x In• tolleranza sulla capacità: -5% / +10%• perdite per dissipazione: $\leq 0,4$ W/kvar• categoria temperatura: -25 / D
Detuning reactors	Tuning frequency: 189 Hz ($\rho = 7\%$) Power losses: 5 W / kvar (AVG) Max. Harmonic distortion of the voltage allowed on the networks is: THDU = 3% (189 Hz). On request: AAR / 6 (THDU = 10%).
Controller	<ul style="list-style-type: none">• type of measurement: varmetric.• amperometric signal: by means of an amperometric transformer with secondary 5A, class 1 - 5VA (by the user)• amperometric signal sensitivity: 2.5% for BMR series, 0.3% for HPR series• switching on / off times of the single capacitor bank: 1 "

QUALITY AND TESTING

Regulations	Capacitors: IEC/EN 60831-1 / 2 certified by IMQ (V1927); Equipment: IEC/EN 61439-1 / 2, IEC/EN 61921.
European directives	Low voltage: 2014/35/CE; Electromagnetic compatibility: 2014/30/CE.
Testing	100% of the automatic equipment is subject to visual inspection, insulation test: phase-phase and phase-earth, battery efficiency and ventilation circuit control: the report is included in the documentation. The capacitors are tested in three consecutive stages of the production process: after winding, regeneration and before labeling.

CONFIGURATION

General notes

- For dimensions, please consult the cabinet drawings, referring to the "Type" column.
- The indication for cable entry (power supply) is as follows: ↑ from the bottom, ↙ side up, ↓ from the top
- The rated power is expressed at 400 V - 50 Hz.

The choice of supply cables depends on the installation conditions, the length of the same and the ambient temperature. For a correct sizing, refer to the IEC 60364-5, CEI 64-8 and the UNEL 35024/01 standards.

Cloud Control System (CCS)

The symbol  indicates that CCS, the remote monitoring system, is pre-installed on the P.F.C. equipment. For any specific information, and to find out the advantages of the Cloud Control System service, refer to the appropriate brochure available on www.comarcond.com or directly on request.

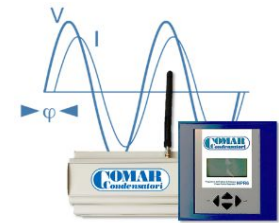





















Table

THD(I)max. = 100%

THD(U)max. = 3%

P = 7%

Code	Type	Qn (kvar)	Cable entry	In (A)	Banks size (kvar)					Steps (n)	Switch isolator (A)	Controlle r (type)	CCS	Weight (kg)
8611402750700	G6E	75	↓	108	12.5	12.5	50			3	160	HPR6		160
8611403100700	G6E	100	↓	144	25	25	50			4	200	HPR6		180
8611403125700	G6E	125	↓	180	25	50	50			5	315	HPR6		200
8611403150700	G6E	150	↓	216	25	50	75			6	400	HPR6		220
8611403175700	G6E	175	↓	252	25	50	50	50		7	400	HPR6		250
8611403200709	G9E	200	↑	288	25	50	50	75		8	500	HPR6		300
8611403225709	G9E	225	↑	324	25	50	75	75		9	500	HPR6		330
8611403250709	G9E	250	↑	360	25	25	50	75	75	10	630	HPR6		350
8611403300709	G9E	300	↑	432	25	50	75	75	75	12	800	HPR6		390
8611403350709	G9E	350	↑	504	50	75	75	75	75	9	800	HPR6		410
8611403400709	G9E (III)	400	↑	576	50	50	75	75	75	14	1000	HPR6		570
8611403450709	G9E (II)	450	↑	648	25	50	75	75	75	18	1000	HPR12		620
8611403500709	G9E (II)	500	↑	720	50	75	75	75	75	13	1250	HPR12		670
8611403550709	G9E (III)	550	↑	792	50	50	75	75	75	19	1250	HPR12		720
8611403600709	G9E (III)	600	↑	864	75	75	75	75	75	8	1250	HPR12		770
8611403650709	G9E (III)	650	↑	936	50	75	75	75	75	16	800+630	HPR12		820
8611403750709	G9E (II)	750	↑	1080	75	75	75	75	150	10	800+800	HPR12		870
8611403825709	G9E (III)	825	↑	1191	75	75	75	75	150	11	800+1000	HPR12		1030
8611403900709	G9E (III)	900	↑	1299	75	75	75	150	150	12	800+1250	HPR12		1080
8611403975709	G9E (III)	975	↑	1407	75	75	75	150	150	13	800+1250	HPR12		1130
8611404105709	G9E (III)	1050	↑	1516	75	75	150	150	150	14	800+1600	HPR12		1180

All automatic P.F.C. series, with or without blocking reactors, can be realized with static insertion.
Other solutions are available on request

On our website you can consult the manuals of our **Controllers!**



www.comarcond.com

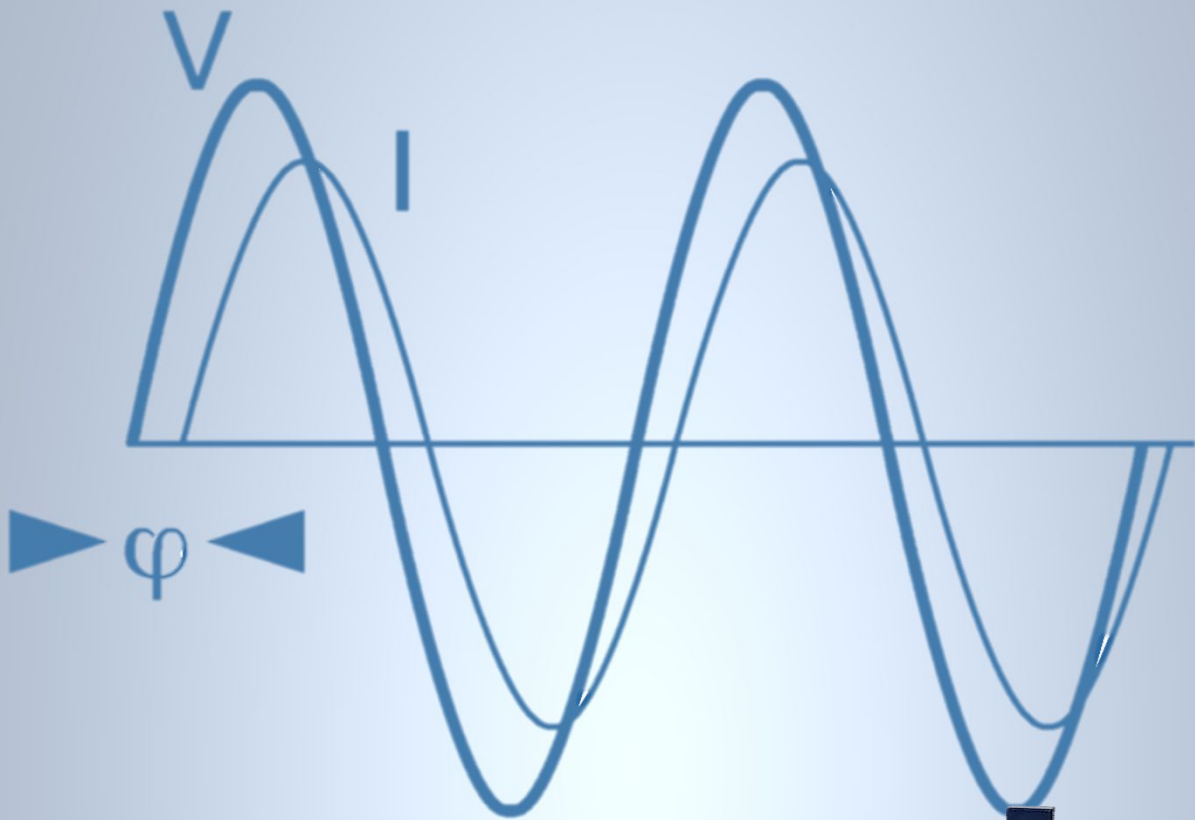



FA05 • FAM05 • FAM05/07

Passive Filters and Passive Modular Three-Phase Filters





FA05 series is specially designed for the knock down of current harmonics generated by U.P.S, in industrial applications. The passive filter is realized by tuning in frequency a capacitor bank and a three-phase reactance. In this way there is a resonant circuit which is chosen as the preferential way from the harmonic current which is to be reduced: in fact, the filter has a sufficiently low impedance value only at the frequency value to which it is tuned.

PERFORMANCE DATA

- **Rated voltage** 400 Vac (others on request)
- **Rated frequency** 50 Hz (60 Hz on request)
- **Insulation voltage** 690 Vac
- **auxiliary voltage** 230 Vac (110 Vac on request)
- **Overvoltage** 1,1 Un (rated voltage)
- **Temperature range** -5 / +40 °C
- **Impulse withstand** 8 kV

TUNED FILTER

5° grade Harmonic

TECHNICAL DATA

Enclosures	Made of sheet steel, protected against corrosion by phosphating and epoxy powder coating. RAL 7032 colour (others on request). Degree of protection: external panel IP 31 (others on request); internal panel IP 20 at the input of power cables (IP 20 with open doors on request).
Ventilation	Forced.
Thermal protection	Made by means of two thermoprobes. The first, with an operating threshold of 35 ° C, controls the insertion of the cooling fans on the roof. The second (50 ° C) separates the filter branch if the temperature exceeds the maximum allowed limit. When the phenomenon ceases, there is automatic recovery.
Insertion	Manual, or automatic piloted remotely (commands by the installer).
Supply	To be carried out directly on the line choke or on the power supply of the fuses. Three-phase input + grounding cable from below for G6E and G8E cabinets. The termination of an NC contact of max 5 Amps 250 Vac for the remote indication of the operation of the equipment is provided by a terminal board. If not used, the remote control must be short-circuited.
Signals	On the front of each panel there is a luminous signal with green light for a live panel, the selector for the insertion of the filter with white light, the intervention of the amperometric protection with yellow light and the relative reset button, the intervention maximum temperature with yellow light signal..
3-pole contactors	Each battery is switched on / off by a three-pole contactor (Class AC6-b) to offer high reliability.
Fuses	Each capacitors bank is protected by fuses. The protection system of both the power circuits (NH-00 curve gG fuses) and the auxiliary ones (isolable fuse holders and 10.3x38 fuses) foresees the use of high breaking power fuses (100kA).
Capacitors	Single-phase capacitors in self-healing metallized polypropylene (MKP), equipped with an anti-burst device and discharge resistance. They are impregnated in vegetable oil, PCB free. Delta connection. Type of continuous service. <ul style="list-style-type: none"> • rated voltage: 500 Vac • overvoltage: 1.1 x A (8h / 24h) • current overload: 1.3 x In • capacity tolerance: -5% / + 10% • losses due to dissipation: ≤0.4 W / kvar • temperature category: -25 / D
Line reactor <small>(on request)</small>	It is manufactured using magnetic low losses core plates. When used, it allows the decoupling of the load and the filter from the network for a correct current sharing between the network and the filter. It also ensures the correct operation of the filter in case of varying distortion in the network.

Filtering reactor It is manufactured using magnetic low losses core plates and it is tuned with the capacitors. Class H and linearity up to 2In.

- agreement frequency of 245Hz (FA05)
- losses due to dissipation: depending on the power of the filter
- maximum possible harmonic distortion in the THD network (v) = 5% (others on request).

Amperometric protection Protects condenser banks by disabling them in case of overcurrents.

QUALITY AND TESTING

Regulations Capacitors: IEC/EN 60831-1 / 2 certified by IMQ (V1927); Equipment: IEC/EN 61439-1 / 2, IEC/EN 61921.

European directives Low voltage: 2014/35/CE; Electromagnetic compatibility: 2014/30/CE.

Testing 100% of the automatic equipment is subject to visual inspection, insulation test: phase-phase and phase-earth, battery efficiency and ventilation circuit control: the report is included in the documentation. The capacitors are tested in three consecutive stages of the production process: after winding, regeneration and before labeling.

CONFIGURATION

General notes

- The rated power is expressed at 400 V - 50 Hz.
- The choice of supply cables depends on the installation conditions, the length of the same and the ambient temperature. For a correct sizing, refer to the IEC 60364-5, CEI 64-8 and the UNEL 35024/01 standards.

The application of the filters involves an in-depth analysis of the operating conditions of the system.

Below is a list of the information essential for a correct sizing:

- Nominal data and operating cycle of the load to be filtered.
- Campaign of harmonic distortion measurements, to determine the frequency and the value of the harmonic current to be reduced.
- Electrical scheme of the system, with indication of the installation point of the filter.
- Presence of power factor correction equipment (automatic or fixed), type and location.
- Nominal data of other distorting loads present in the system.

Table

Code	Load Data			Filter Data					
	Max. power load U.P.S.	Pn ¹	Rated current	5th harmonic current to be filtered	Reactive power	Reactive current	Impact resistance degree	Type	Weight
	(kVA)	(kW)	(A)	(A)	(kvar)	(A)		(mm)	(kg)
FA05 15-400	15	12	22	8	6	9	IK05	G6E	60
FA05 20-400	20	16	30	12	8	11	IK05	G6E	71
FA05 30-400	30	24	42	16	10	14	IK05	G6E	79
FA05 40-400	40	32	60	24	13	19	IK05	G6E	95
FA05 55-400	55	44	80	32	18	25	IK05	G6E	105
FA05 70-400	70	56	100	40	22	32	IK05	G6E	115
FA05 90-400	90	72	130	52	26	38	IK10	G6E	240
FA05 110-400	110	88	160	64	32	46	IK10	G8E	265
FA05 140-400	140	112	200	80	41	59	IK10	G8E	280
FA05 180-400	180	144	260	105	52	75	IK10	G8E	305
FA05 230-400	230	184	330	132	67	97	IK10	G8E	340
FA05 270-400	270	216	390	155	79	114	IK10	G8E	385
FA05 320-400	320	256	460	185	97	140	IK10	G8E	415
FA05 360-400	360	288	520	210	110	159	IK10	G8E	430
FA05 410-400	410	328	590	236	123	178	IK10	G8E	450
FA05 450-400	450	360	650	260	138	199	IK10	G8E	475
FA05 500-400	500	400	720	288	152	219	IK10	G8E (II)	490
FA05 550-400	550	440	790	310	167	241	IK10	G8E (II)	530
FA05 600-400	600	480	865	340	182	263	IK10	G8E (II)	720

(1) Sizing realized considering the working load at full power and an average $\cos \varphi$ of the line = 0.80



PERFORMANCE DATA

■ Rated voltage	400 Vac (altre a richiesta)
■ Rated frequency	50 Hz (a richiesta 60 Hz)
■ Insulation voltage	690 Vac
■ auxiliary voltage	230 Vac
■ Overvoltage	1,1 Un (tensione nominale)
■ Temperature range	-5 / +40 °C
■ Impulse withstand	8 kV

TUNED FILTER

Filtri di 5^a Armonica

FAM05 is realized by appropriately tuning in frequency, a battery of capacitors and a three-phase reactance. In this way a resonant circuit is realized which is chosen as the preferred way from the harmonic current which is to be reduced, and is equipped with a **microprocessor control system** for inserting modules. Features:

- consisting of standard racks of equal dimensions connected to each other
- Easily increases the size of the filter
- prevents the insertion of filter groups L-C, having too high reactive power, bring the power factor of the load to a capacitive $\cos\phi$, with possible consequent problems of DC drives.

TECHNICAL DATA

Enclosures	Made of sheet steel, protected against corrosion by phosphating and epoxy powder coating. RAL 7032 colour (others on request). Degree of protection: external panel IP 31 (others on request); internal panel IP 20 at the input of power cables (IP 20 with open doors on request).
Ventilation	Forced.
Thermal protection	Made by means of two thermoprobes. The first, with an operating threshold of 35 ° C, controls the insertion of the cooling fans on the roof. The second (50 ° C) separates the filter branch if the temperature exceeds the maximum allowed limit. When the phenomenon ceases, there is automatic recovery.
Insertion	Manual, or automatic piloted remotely (commands by the installer).
Supply	To be carried out directly on the line choke or on the power supply of the fuses. Three-phase input + grounding cable from below for G6E and G8E cabinets. The termination of an NC contact of max 5 Amps 250 Vac for the remote indication of the operation of the equipment is provided by a terminal board. If not used, the remote control must be short-circuited.
Signals	On the front of each panel there is a luminous signal with green light for a live panel, the selector for the insertion of the filter with white light, the intervention of the amperometric protection with yellow light and the relative reset button, the intervention maximum temperature with yellow light signal..
3-pole contactors	Each battery is switched on / off by a three-pole contactor (Class AC6-b) to offer high reliability.
Fuses	Each capacitors bank is protected by fuses. The protection system of both the power circuits (NH-00 curve gG fuses) and the auxiliary ones (isolable fuse holders and 10.3x38 fuses) foresees the use of high breaking power fuses (100kA).
Capacitors	Single-phase capacitors in self-healing metallized polypropylene (MKP), equipped with an anti-burst device and discharge resistance. They are impregnated in vegetable oil, PCB free. Delta connection. Type of continuous service. <ul style="list-style-type: none"> • rated voltage: 550 Vac • overvoltage: 1.1 x A (8h / 24h) • current overload: 1.3 x In • capacity tolerance: -5% / + 10% • losses due to dissipation: $\leq 0.4 \text{ W / kvar}$ • temperature category: -25 / D

Filtering reactor	<p>It is manufactured using magnetic low losses core plates and it is tuned with the capacitors. Class H and linearity up to 2In.</p> <ul style="list-style-type: none"> • agreement frequency of 245Hz (FA05) • losses due to dissipation: depending on the power of the filter • maximum possible harmonic distortion in the THD network (v) = 5% (others on request).
Amperometric protection	<p>Protects condenser banks by disabling them in case of overcurrents.</p>

QUALITY AND TESTING

Regulations	Capacitors: IEC/EN 60831-1 / 2 certified by IMQ (V1927); Equipment: IEC/EN 61439-1 / 2, IEC/EN 61921.
European directives	Low voltage: 2014/35/CE; Electromagnetic compatibility: 2014/30/CE.
Testing	100% of the automatic equipment is subject to visual inspection, insulation test: phase-phase and phase-earth, battery efficiency and ventilation circuit control: the report is included in the documentation. The capacitors are tested in three consecutive stages of the production process: after winding, regeneration and before labeling.

CONFIGURATION

General notes

- The rated power is expressed at 400 V - 50 Hz.
- The choice of supply cables depends on the installation conditions, the length of the same and the ambient temperature. For a correct sizing, refer to the IEC 60364-5, CEI 64-8 and the UNEL 35024/01 standards.

The application of the filters involves an in-depth analysis of the operating conditions of the system.

Below is a list of the information essential for a correct sizing:

- Nominal data and operating cycle of the load to be filtered.
- Campaign of harmonic distortion measurements, to determine the frequency and the value of the harmonic current to be reduced.
- Electrical scheme of the system, with indication of the installation point of the filter.
- Presence of power factor correction equipment (automatic or fixed), type and location.
- Nominal data of other distorting loads present in the system.

Table

Code	Load Data			Filter Data				
	Max. power load U.P.S. (kVA)	Pn ¹ (kW)	Rated current (A)	In max. to be filtered at 250 Hz (A)	Qtot (kvar)	Steps Combination (A)	Type	Weight (kg)
FAM 05 120-400	120	96	172	70	32	16+16	G6E	210
FAM 05 180-400	180	144	258	105	48	32+16	G6E	230
FAM 05 240-400	240	192	344	140	64	22+22+22	G6E	250
FAM 05 320-400	320	256	460	200	88	44+44	G6E	290
FAM 05 400-400	400	320	570	250	110	44+44+22	G8E	390
FAM 05 480-400	480	384	690	300	132	44+44+44	G8E	430
FAM 05 560-400	560	448	800	350	154	66+44+44	G8E (II)	560
FAM 05 640-400	640	512	920	400	176	66+66+44	G8E (II)	640
FAM 05 720-400	720	576	1040	450	198	66+66+66	G8E (II)	730
FAM 05 800-400	800	640	1150	500	220	88+66+66	G8E (II)	810
FAM 05 880-401	880	704	1270	550	242	88+88+66	G8E (II)	890
FAM 05 960-400	960	768	1386	600	264	88+88+88	G8E (III)	1020
FAM 05 1040-400	1040	832	1501	650	286	110+88+88	G8E (III)	1100
FAM 05 1120-400	1120	896	1617	700	308	110+110+88	G8E (III)	1180
FAM 05 1200-400	1200	960	1732	750	330	110+110+110	G8E (III)	1260
FAM 05 1280-400	1280	1024	1848	800	352	132+110+110	G8E (III)	1340

(1) Sizing realized considering the working load at full power and an average $\cos \varphi$ of the line = 0.80



FAM05/07 is realized by appropriately tuning in frequency, a battery of capacitors and a three-phase reactance. In this way a resonant circuit is realized which is chosen as the preferred way from the harmonic current which is to be reduced, and is equipped with a **microprocessor control system** for inserting modules.

Features:

- consisting of standard racks of equal dimensions connected to each other
- Easily increases the size of the filter
- prevents the insertion of filter groups L-C, having too high reactive power, bring the power factor of the load to a capacitive $\cos\phi$, with possible consequent problems of DC drives.

PERFORMANCE DATA

■ Rated voltage	400 Vac (altre a richiesta)
■ Rated frequency	50 Hz (a richiesta 60 Hz)
■ Insulation voltage	690 Vac
■ auxiliary voltage	230 Vac
■ Overvoltage	1,1 Un (tensione nominale)
■ Temperature range	-5 / +40 °C
■ Impulse withstand	8 kV

TUNED FILTER

5° and 7° grade Harmonic

TECHNICAL DATA

Enclosures	Made of sheet steel, protected against corrosion by phosphating and epoxy powder coating. RAL 7032 colour (others on request). Degree of protection: external panel IP 31 (others on request); internal panel IP 20 at the input of power cables (IP 20 with open doors on request).
Ventilation	Forced.
Thermal protection	Made by means of two thermoprobes. The first, with an operating threshold of 35 ° C, controls the insertion of the cooling fans on the roof. The second (50 ° C) separates the filter branch if the temperature exceeds the maximum allowed limit. When the phenomenon ceases, there is automatic recovery.
Insertion	Manual, or automatic piloted remotely (commands by the installer).
Supply	To be carried out directly on the line choke or on the power supply of the fuses. Three-phase input + grounding cable from below for G6E and G8E cabinets. The termination of an NC contact of max 5 Amps 250 Vac for the remote indication of the operation of the equipment is provided by a terminal board. If not used, the remote control must be short-circuited.
Signals	On the front of each panel there is a luminous signal with green light for a live panel, the selector for the insertion of the filter with white light, the intervention of the amperometric protection with yellow light and the relative reset button, the intervention maximum temperature with yellow light signal..
3-pole contactors	Each battery is switched on / off by a three-pole contactor (Class AC6-b) to offer high reliability.
Fuses	Each capacitors bank is protected by fuses. The protection system of both the power circuits (NH-00 curve gG fuses) and the auxiliary ones (isolable fuse holders and 10.3x38 fuses) foresees the use of high breaking power fuses (100kA).
Capacitors	Single-phase capacitors in self-healing metallized polypropylene (MKP), equipped with an anti-burst device and discharge resistance. They are impregnated in vegetable oil, PCB free. Delta connection. Type of continuous service. <ul style="list-style-type: none"> • rated voltage: 550 Vac • overvoltage: 1.1 x A (8h / 24h) • current overload: 1.3 x In • capacity tolerance: -5% / + 10% • losses due to dissipation: ≤ 0.4 W / kvar • temperature category: -25 / D

Filtering reactor It is manufactured using magnetic low losses core plates and it is tuned with the capacitors. Class H and linearity up to $2I_n$.

- agreement frequency of 245Hz and 345 Hz
- losses due to dissipation: depending on the power of the filter
- maximum possible harmonic distortion in the THD network (v) = 5% (others on request).

Amperometric protection Protects condenser banks by disabling them in case of overcurrents.

QUALITY AND TESTING

Regulations Capacitors: IEC/EN 60831-1 / 2 certified by IMQ (V1927); Equipment: IEC/EN 61439-1 / 2, IEC/EN 61921.

European directives Low voltage: 2014/35/CE; Electromagnetic compatibility: 2014/30/CE.

Testing 100% of the automatic equipment is subject to visual inspection, insulation test: phase-phase and phase-earth, battery efficiency and ventilation circuit control: the report is included in the documentation. The capacitors are tested in three consecutive stages of the production process: after winding, regeneration and before labeling.

CONFIGURATION

General notes

- The rated power is expressed at 400 V - 50 Hz.
- The choice of supply cables depends on the installation conditions, the length of the same and the ambient temperature. For a correct sizing, refer to the IEC 60364-5, CEI 64-8 and the UNEL 35024/01 standards.

The application of the filters involves an in-depth analysis of the operating conditions of the system.

Below is a list of the information essential for a correct sizing:

- Nominal data and operating cycle of the load to be filtered.
- Campaign of harmonic distortion measurements, to determine the frequency and the value of the harmonic current to be reduced.
- Electrical scheme of the system, with indication of the installation point of the filter.
- Presence of power factor correction equipment (automatic or fixed), type and location.
- Nominal data of other distorting loads present in the system.

Table

Code	Load Data			Filter Data				
	Max. power load U.P.S (kVA)	Pn ¹ (kW)	Rated current (A)	Max. current to be filtered at 250 Hz+350Hz (A)	Qtot (kvar)	Steps Combination (A)	Type	Weight (kg)
FAM 05/07 120-400	120	96	172	70+25	48	32+16	G6E	230
FAM 05/07 180-400	180	144	258	105+50	80	32+32+16	G8E	340
FAM 05/07 240-400	240	192	344	140+50	96	48+32+16	G8E	360
FAM 05/07 320-400	320	256	460	200+100	132	88+44	G8E	430
FAM 05/07 400-400	400	320	570	250+150	176	88+66+22	G8E (II)	640
FAM 05/07 480-400	480	384	690	300+200	220	88+88+44	G8E (II)	810
FAM 05/07 560-400	560	448	800	350+250	264	88+88+88	G8E (III)	1020
FAM 05/07 640-400	640	512	920	400+300	308	110+110+88	G8E (III)	1180
FAM 05/07 720-400	720	576	1040	450+300	330	110+110+110	G8E (III)	1260
FAM 05/07 800-400	800	640	1150	500+300	352	132+110+110	G8E (III)	1340

(1) Sizing realized considering the working load at full power and an average $\cos \varphi$ of the line = 0.80



SAF-M

Modular Active Filter





The new series of **SAF-M** active filters represents the ideal solution to compensate for the most demanding harmonic currents, with any type of non-linear load involved, and have a **modular design** specifically designed for easy cabinet assembly and application flexibility.

DATI DI PERFORMANCE

■ Mains voltage	3-wire: 380 - 480 Vac 4-wire: 380 - 415 Vac
■ Rated frequency	50 Hz / 60Hz
■ Inverter topology	3-level NPC topology, IGBT
■ Switching frequency	16 kHz
■ Response time	<100 μ s
■ Compensated harmonic currents	Up To the 50 th harmonic (even and odd harm. orders)
■ Residual THDI (in current)	< 5%
■ Supply	Three-phase, 3-wire or 4-wire (three-phase+neutral)
■ Max. rated phase / neutral conductor mitigation current	60 Arms / 180 Apk

TECHNICAL DATA

Power factor correction	$\cos \varphi = -0.7 \dots 1 \dots 0.7$ (inductive and capacitive compensation).
Power losses	<1100 W under full mitigation performance (<2.6%) <970 W in typical operation (<2.3%)
Communication interface	Ethernet TCP/IP, Modbus RTU RS 485
Digital I/O	2 DI + 2 DO
C.T. ratio	xx:5 A or xx:1 A
Degree of protection	IP 20 / 21.
Weight (single module)	44 Kg.
Mounting	Wall-mounting (book or flat mounting).
Ambient temperature	0 ... 50°C full performance, up to 55°C with degrading of 3% per Kelvin.
Noise level	< 56 to 63 dB A (depending on load situation).
Altitude	< 1000 m without degrading; up to 4000 m with degrading 1% / 100 m.

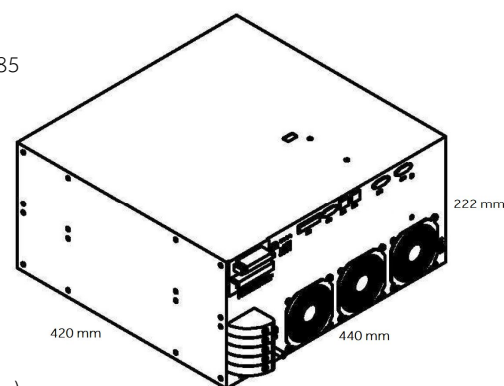

Display Module

Furthermore, the SAF-M filter is equipped with the LCD display module, which is used to monitor the measured values of the three-phase network and to change the filter parameters. A display module adapts to all power supply modules and can be used in any system configuration, whether it is a single power supply module, a double power supply unit or a cabinet installation.



QUALITY AND APPROVALS

Reference standards IEE 519, EN 61000-3-12

Certifications CE, UL

Our Active Filter solutions, and the related codes, are available upon request

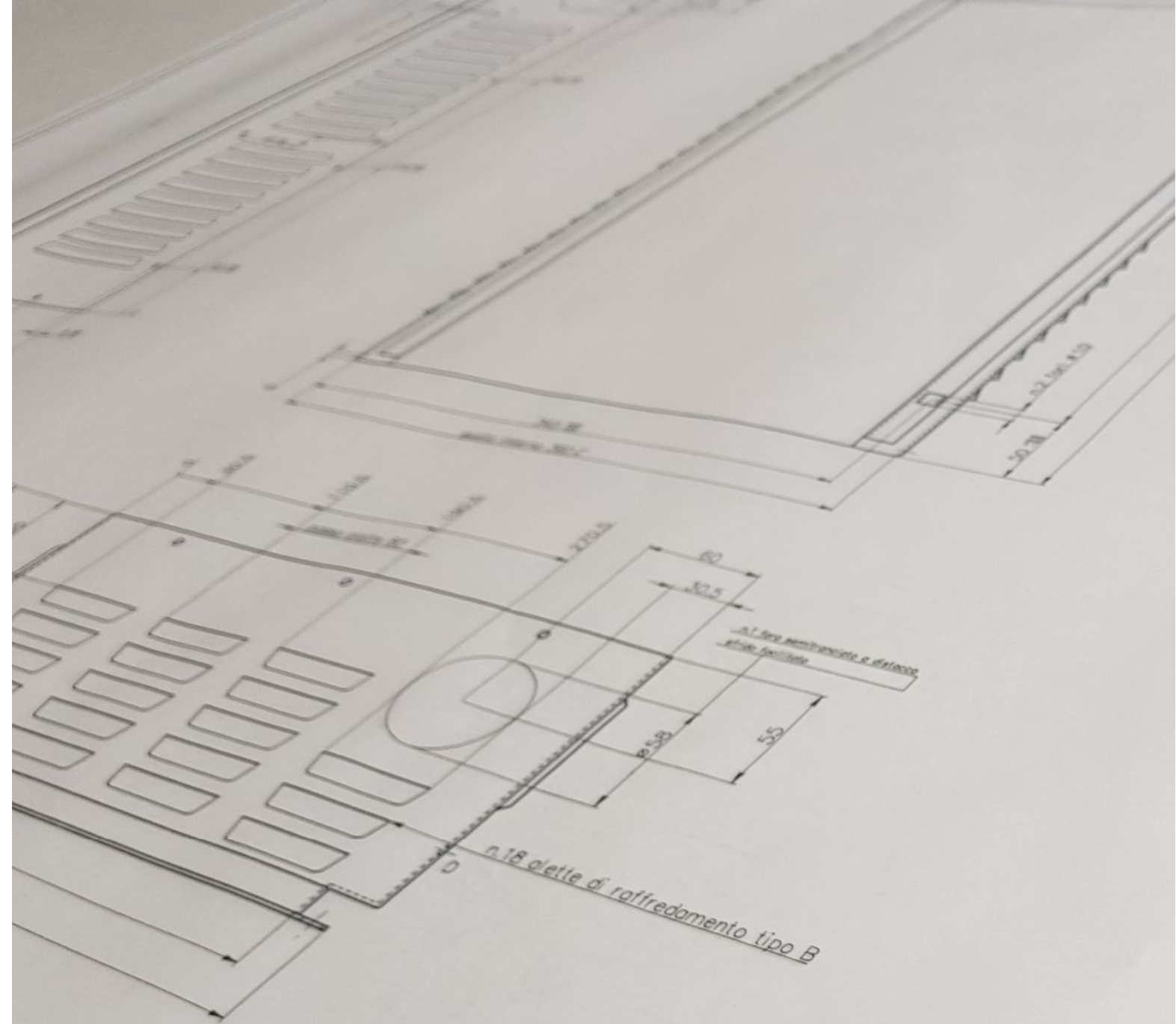

Mechanical Drawings



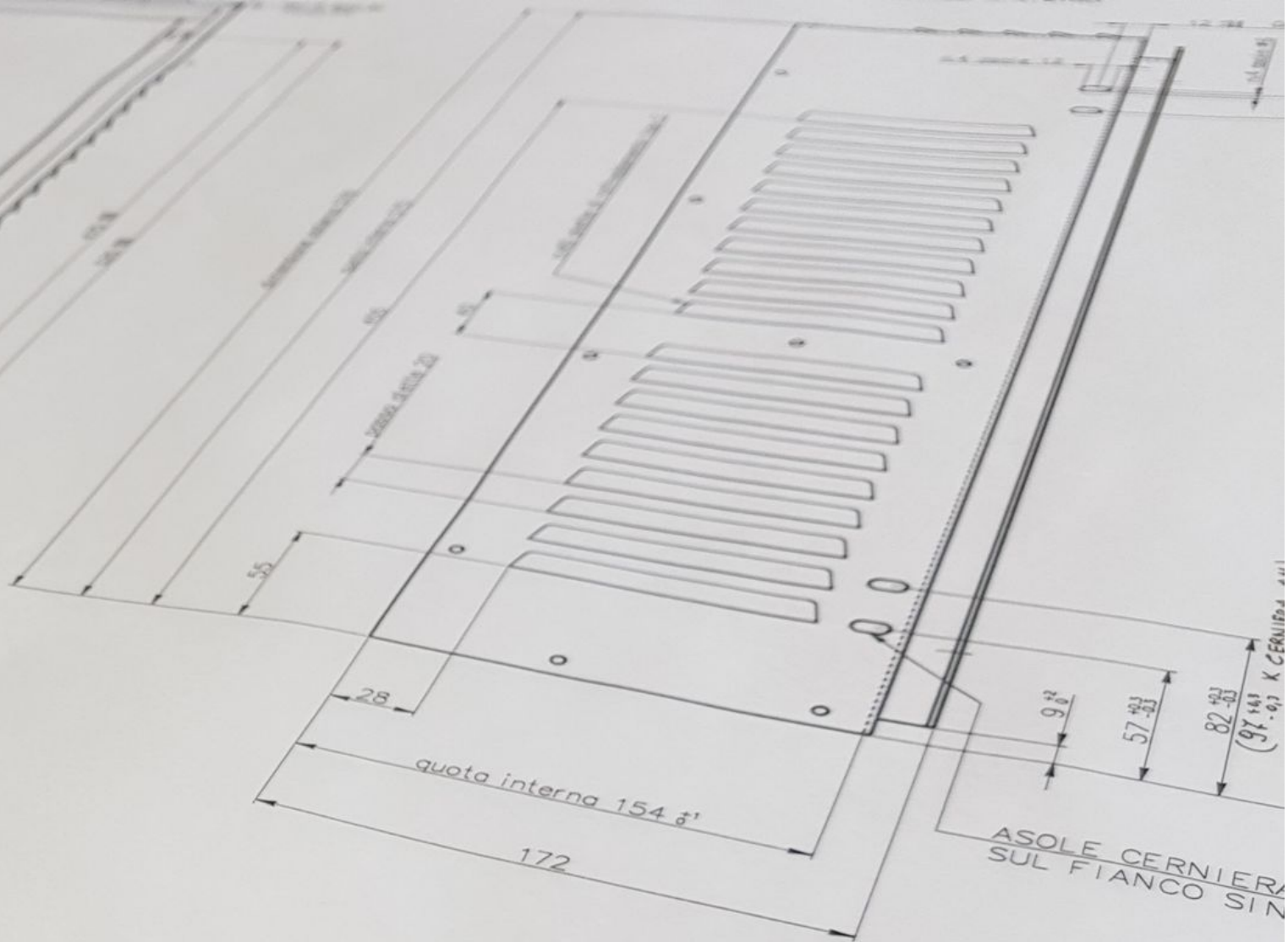

PART. ALETTE DI RAFFREDDAMENTO tip
scala 1 : 1

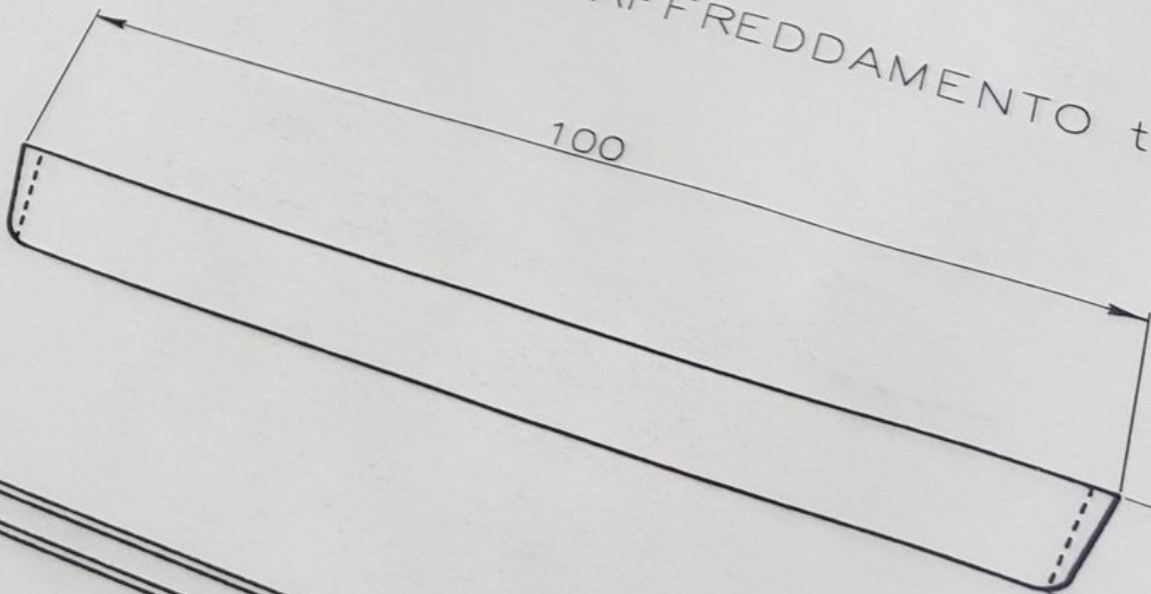

G3E

Cabinet for wall mounting



For powers up to 31.25 kvar

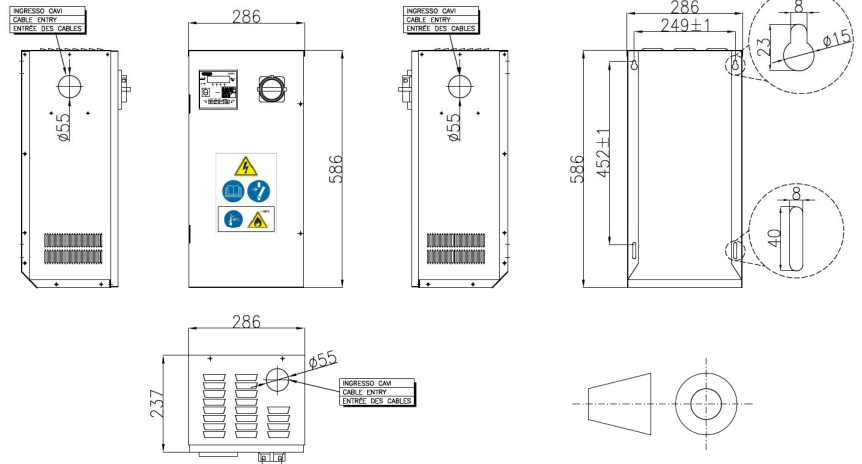

For powers over 31.25 kvar

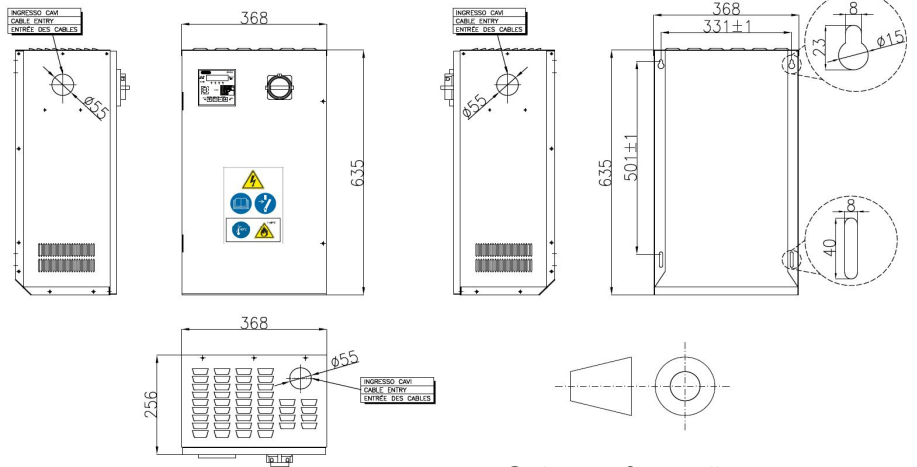

G4E

Cabinet for wall mounting

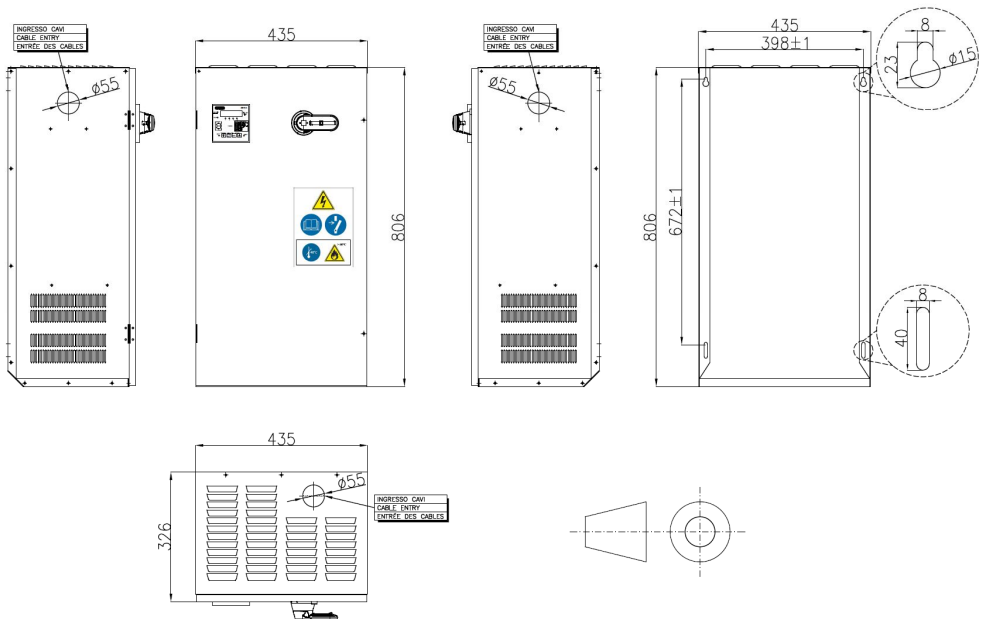

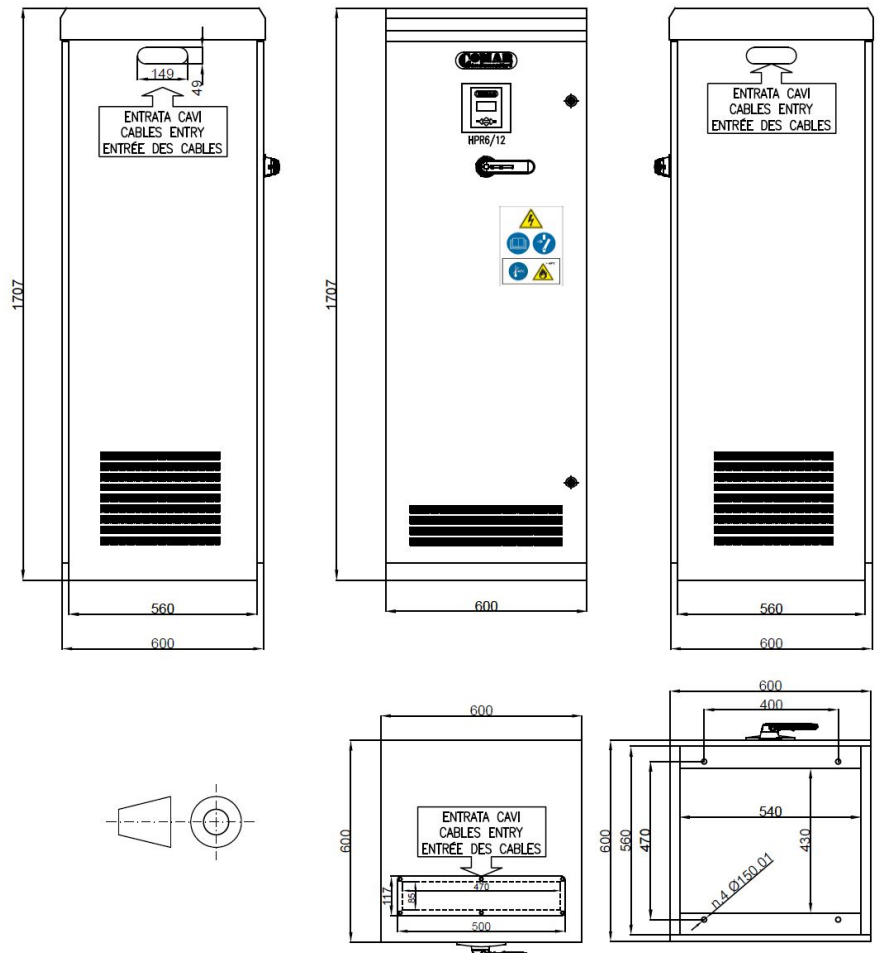
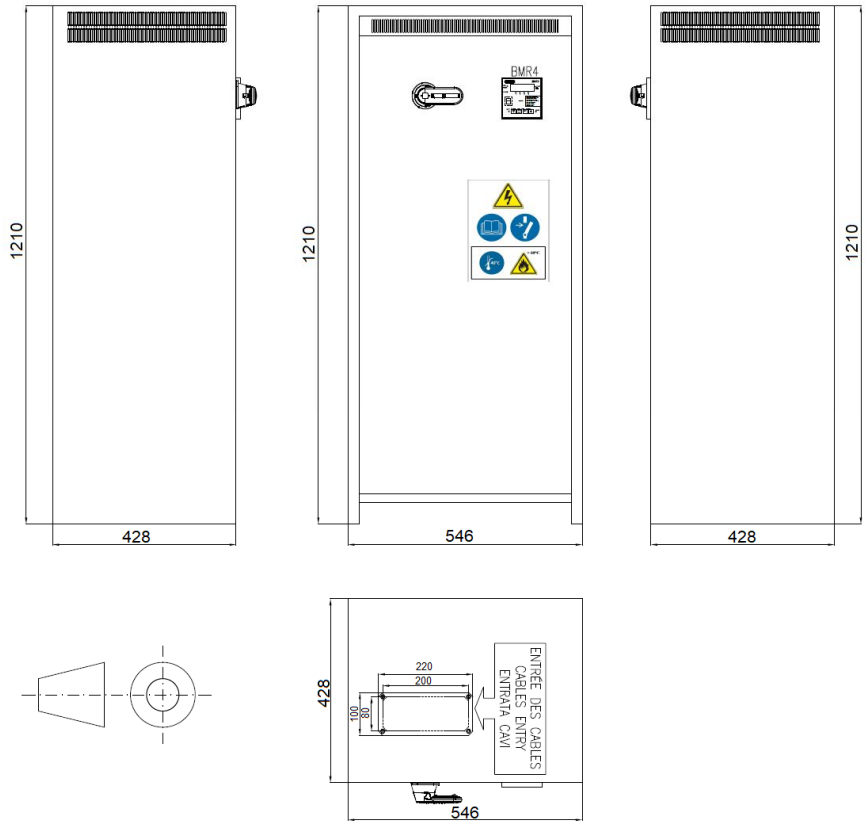



G8E(II) cabinet

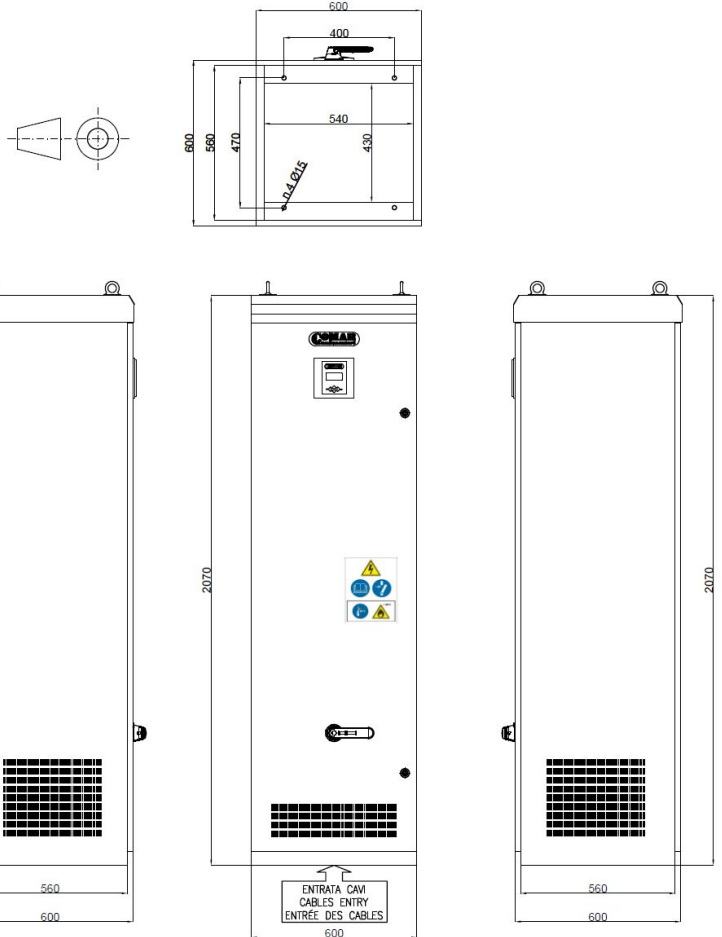

G8E (II)

Cabinet for floor mounting

G8E (III)

2-door cabinet:

3-door cabinet:

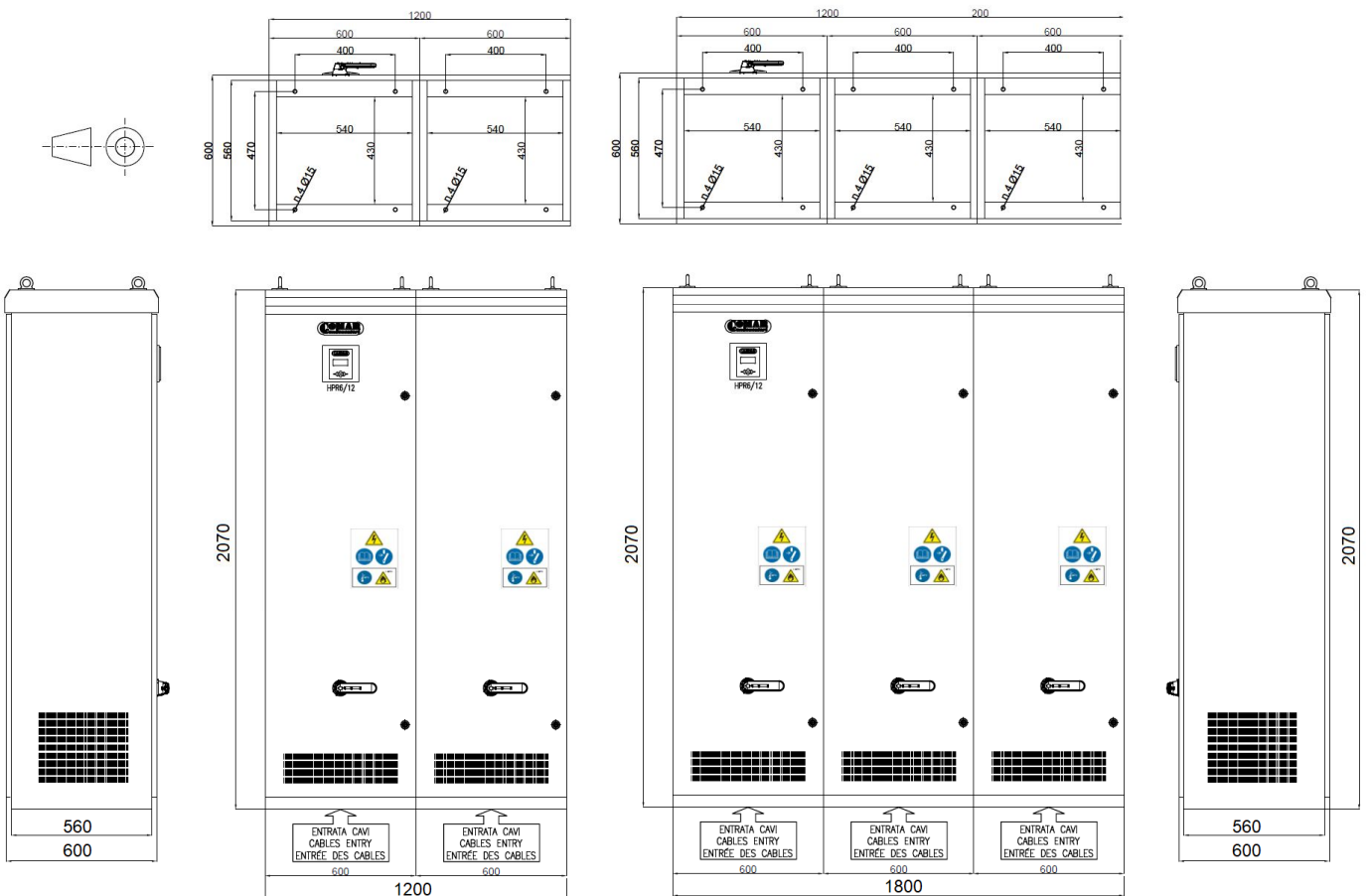



G9E(II) cabinet

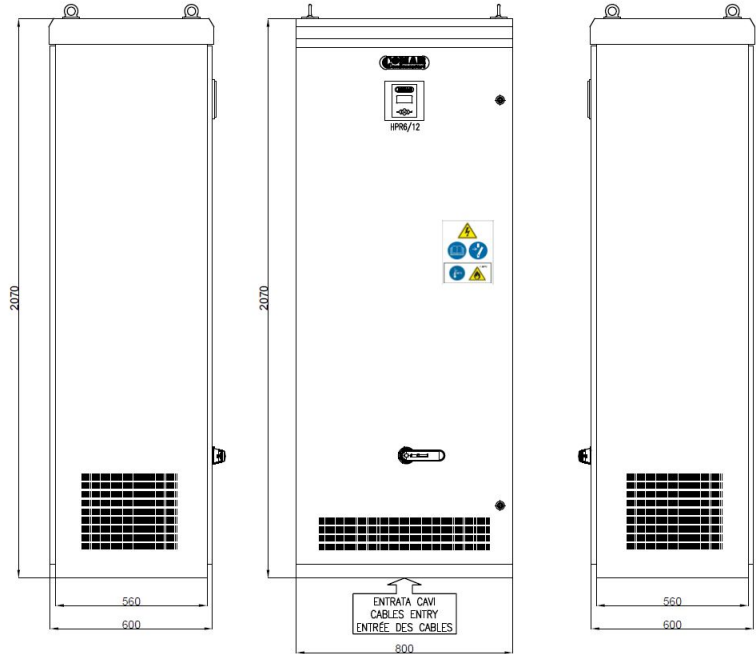
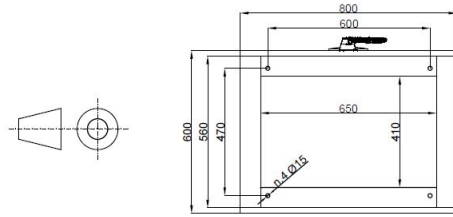

G9E (II)

Cabinet for floor mounting

G9E (III)

2-door cabinet:

3-door cabinet:

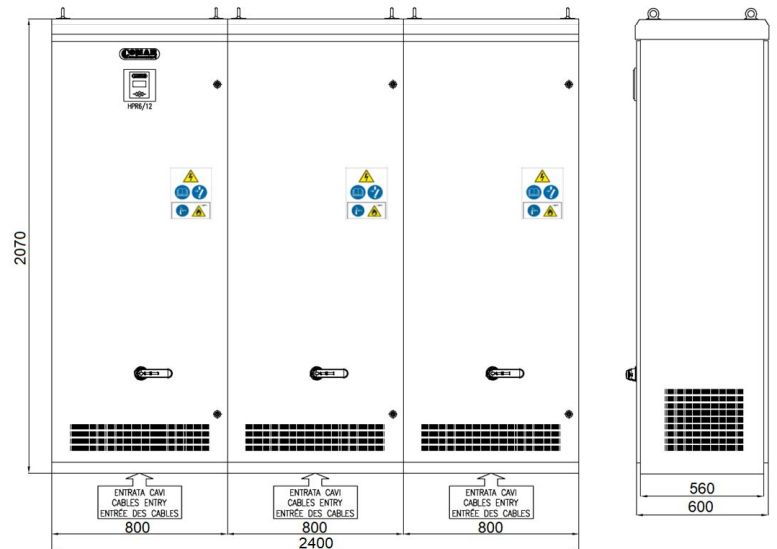
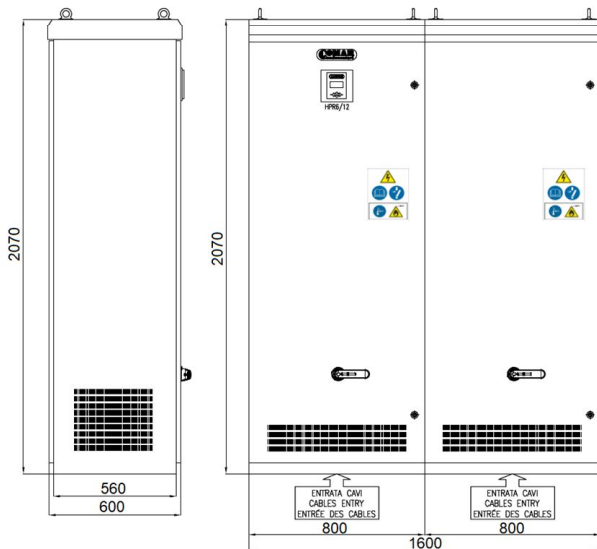
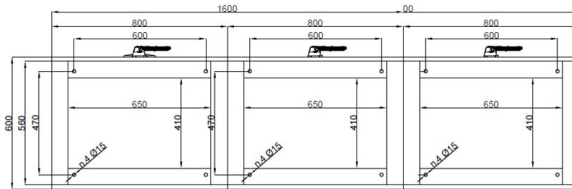
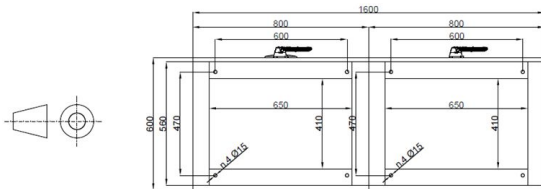

Terms of use

The contents of this catalog and the logo are owned by COMAR Condensatori S.p.A.. It follows that they can not, either in whole or in part, be copied, reproduced, transferred, uploaded, published or distributed in any way without the prior written consent of COMAR Condensatori S.p.A.

Limitation of liability

COMAR Condensatori S.p.A. provides the information in this catalog deeming them accurate as of its publication date. In no case COMAR Condensatori S.p.A. will be held responsible for any direct or indirect damage caused by the use of this catalog. The information can be modified or updated by COMAR Condensatori S.p.A. without prior notice.



Do you have any other question? Feel free to ask:

export@comarcond.com



+39 051 733383



Fixed Power Factor Correction
Automatic Power Factor Correction
Automatic P.F.C. with Detuning Reactors
Automatic P.F.C. with Static Insertion
Passive Filters and Passive Modular Three-Phase Filters
Modular Active Filters



COMAR Condensatori S.p.A.
Via del Lavoro, 80 – Loc. Crespellano
40053 Valsamoggia (Bologna) – Italy
Tel. +39 051 733383 – Fax. +39 051 733620

